

## LCR HiTESTER 3535

Component measuring instruments



HEAD AMP UNIT

Measure across the broad frequency range of 100kHz to 120MHz with the new Model **LCR HiTESTER 3535**. The 6ms high-speed measurement capability is particularly useful with the built-in comparator and load functions, and for BIN (classification) measurements, to suit a wide range of applications such as chip inductor and high speed magnetic head testing, as well as other related research needs. Achieve ultimate measurement flexibility by detaching the head amp unit from the main unit and placing it in proximity to the test object so as to minimize the effect of test leads on measurements. The 3535's low price, ideal size and light weight are all achieved by incorporating an automatically balanced bridge circuit with digital control. Never before has such an advanced precision instrument coupled with economical features been placed on the test and measurement market.



ISO 9001  
JMI-0216



ISO 14001  
JQA-E-90091



[www.hioki.com](http://www.hioki.com)

HIOKI company overview, new products, environmental considerations and other information are available on our website.



# Detachable Head Amp

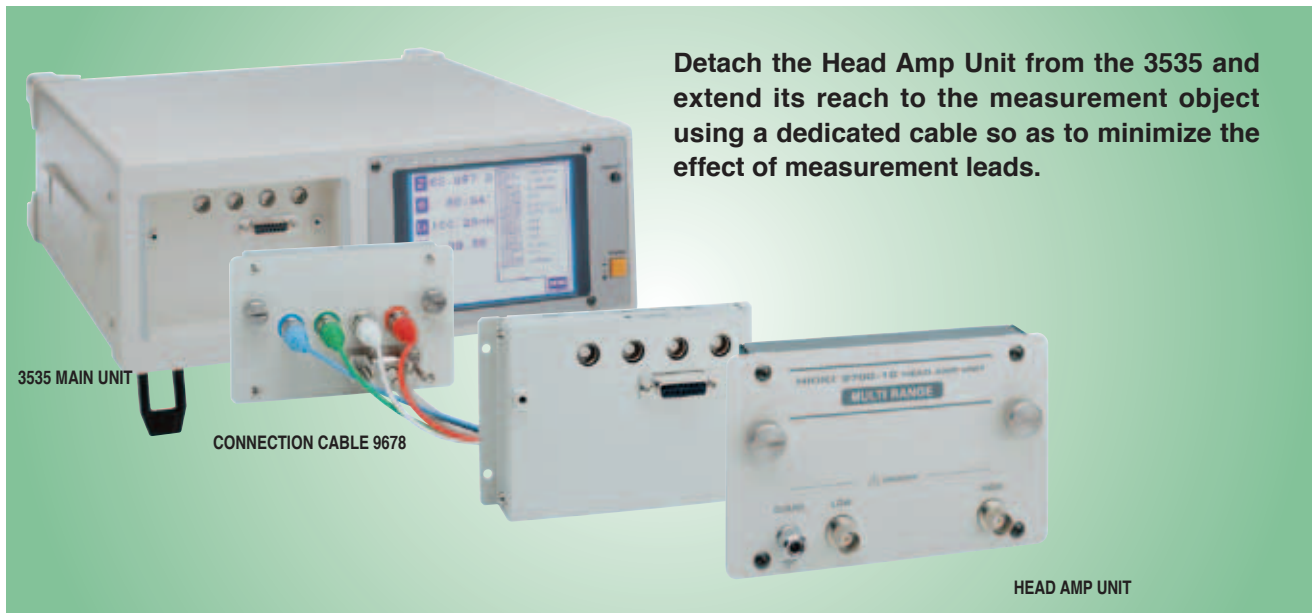

Detach the Head Amp Unit from the 3535 and extend its reach to the measurement object using a dedicated cable so as to minimize the effect of measurement leads.

## Broad Frequency Measurement Range

The measurement frequency is set with four-digit resolution from 100 kHz to 120 MHz.

## 6-millisecond Minimum Measurement Time

Four sampling rates can be selected: FAST, NORMAL, SLOW and SLOW2. The minimum measurement time of about 6 ms (displaying |Z|) provides rapid sampling for optimum production line efficiency.

(The measurement frequency range depends on the measured parameter type).

## 14 Parameter Types

The following parameters can be measured, and selected parameters can be captured using a PC. |Z|, |Y|,  $\theta$ , Rp, Rs (ESR), G, X, B, Lp, Ls, Cp, Cs, D (tan $\delta$ ) and Q.

## Adjust for Conditions While Measuring

Measurement frequency, signal level and other conditions can be changed while monitoring measurement values, showing the effects of trial measurements and test condition settings.

## Store Measurement Data

Up to 200 measurement values can be stored in the main unit. Saved values can be transferred to a computer or printed all at once.

## Zoom Display

Up to four parameters can be displayed enlarged, for easy observation of the measurement values on production lines and in other situations where the display has to be monitored from a distance.

## Printer Output

With the optional 9442 PRINTER, measurement values, comparator results and screen data can be printed.

## BIN (Classification) Measurement

Using up to ten classifications of two measurements, measurement values can be easily classified by rank.

## Continuous Measurements

Store up to 30 sets of measurement conditions. Of multiple conditions stored in memory, up to five measurements can be made sequentially per condition saved on the screen. With the comparator function, the results of a sequence of measurements can be logically ANDed and output from a single instrument.

## Load Compensation Function

A standard component can be measured to obtain a compensation amount to be applied to subsequent measurement values. This function is useful for matching measurement values between different instruments.

## For Changing Production Lines

Utilize the ability to store up to 30 sets of measurement conditions, including comparator values, to provide rapid response to frequent component changes on flexible production lines.

## Simultaneously Measure up to 4 Parameters

Any four of fourteen parameter types can be selected for simultaneous measurement and display.

## Correlation Compensation Function

The constants a and b can be set in the following compensation function expression:

$$\text{Compensation value} = a \times \text{measurement value} + b$$

# Automatically Balanced Bridge Circuit with Digital Control

## EXT I/O

Externally control triggering and loading of measurement conditions, and for automated lines, configure output signals including comparator results and end-of-measurement signals at the touch of a button.

EXT I/O Signals	
● <b>Outputs</b>	<ul style="list-style-type: none"> <li>Internal DC Power (+5 V output)</li> <li>Comparator Results</li> <li>BIN (Classification) Measurement Results</li> <li>End-of-Measurement Signal</li> </ul>
● <b>Inputs</b>	<ul style="list-style-type: none"> <li>External DC Power Supply (+5 to 24 V can be provided by an external source)</li> <li>External Trigger Signal</li> <li>Selection of Panels for Loading</li> </ul>

## External Control using a PC

Both RS-232C and GP-IB interfaces are included for external control of all functions (except Power ON/OFF of the 3535 main unit) from a computer.

### RS-232C Interface

**Transfer Method:** Communications Method: Full Duplex, Synchronization Method: Start-Stop Asynchronous  
**Transfer Speed:** 9,600 or 19,200 bps  
**Data Length:** 8 bits  
**Parity:** none  
**Stop Bit:** 1 bit  
**Delimiter:** CR+LF or CR  
**Flow Control:** none  
**Connector:** 9-pin D-sub male, reverse wired

### GP-IB Interface

**Supported Standard:** IEEE-488.1 1987  
 IEEE-488.2 1987 common (required) commands can be used.

## Timing Chart for EXT I/O Sequencing

The following chart shows the timing sequence of the trigger (TRIG), end-of-measurement (EOM) signals and comparator result signals from the EXT I/O connector.

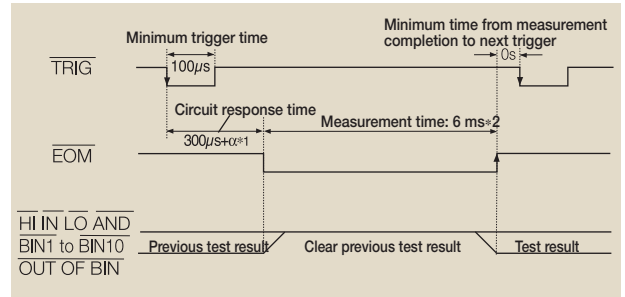

\* 1.  $\alpha$  depends on the component and trigger delay.  
 \* 2. Reference value with FAST measurement speed, Averaging OFF and Z measurement selected.

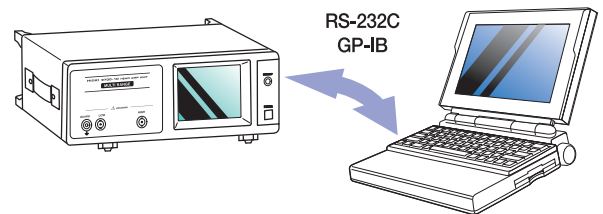

Any voltage from 100 to 240 VAC

Keylock key prevents unintended operations from inadvertent touching of display panel

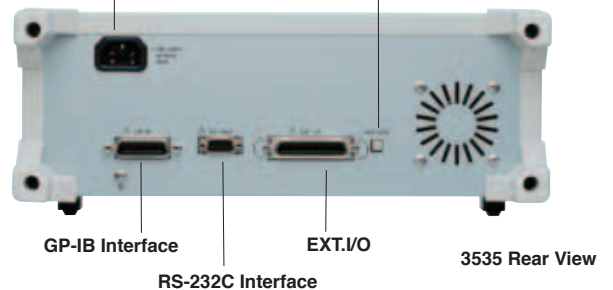

## Measurement Principle Automatically Balanced Bridge Circuit with Digital Control

The measurement signal is generated by a primary oscillator and applied to the component (DUT). The LOW terminal voltage is measured and used to control the phase and amplitude of a secondary oscillator so as to maintain a balanced condition (LOW terminal voltage being zero). The impedance  $Z$  and phase angle  $\theta$  of the DUT are determined according to the amplitude and phase required to maintain the secondary oscillator in its balanced condition.

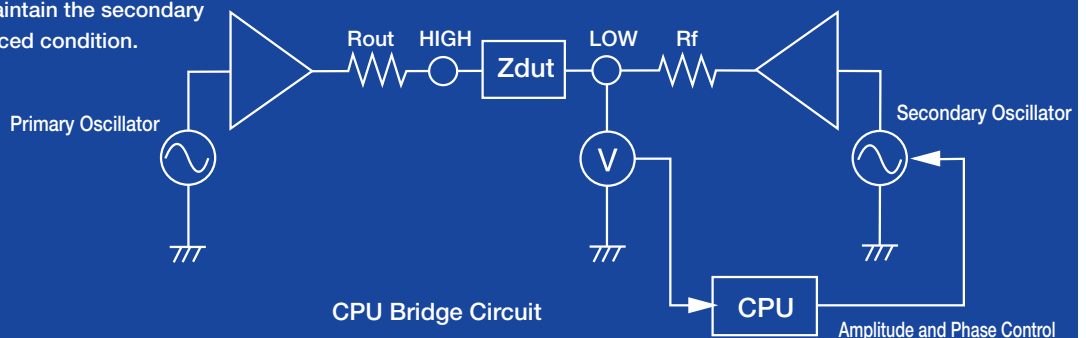



# Changing Settings While Measuring

## Simple Touch Panel Operation

Make all measurement condition settings from the easy-to-use touch panel. Active keys appear in reverse video, providing simple, dialog-type operation by lightly touching the item or number to be set. Real-time display of measurement data on the settings screen provide convenient monitoring while changing test signal settings. Zoom display up to 4 parameters for enhanced visibility at a distance on production lines.

Note: The screens show typical examples on the 3535.

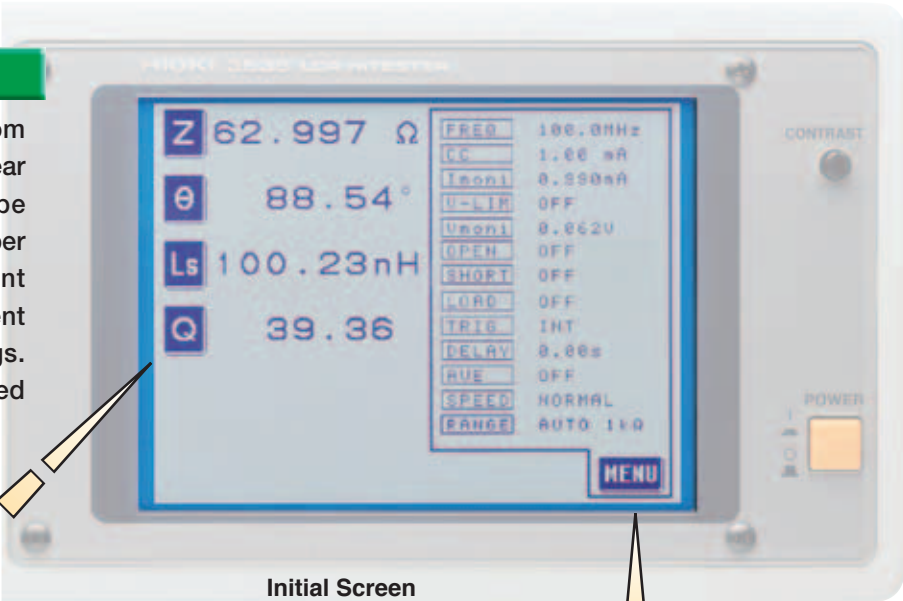

**Initial Screen**

Shows measurement values for any four selected parameters, and the current setting conditions.

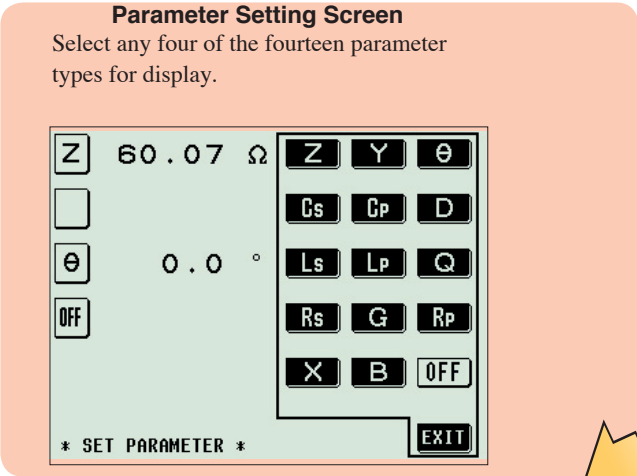

### Parameter Setting Screen

Select any four of the fourteen parameter types for display.

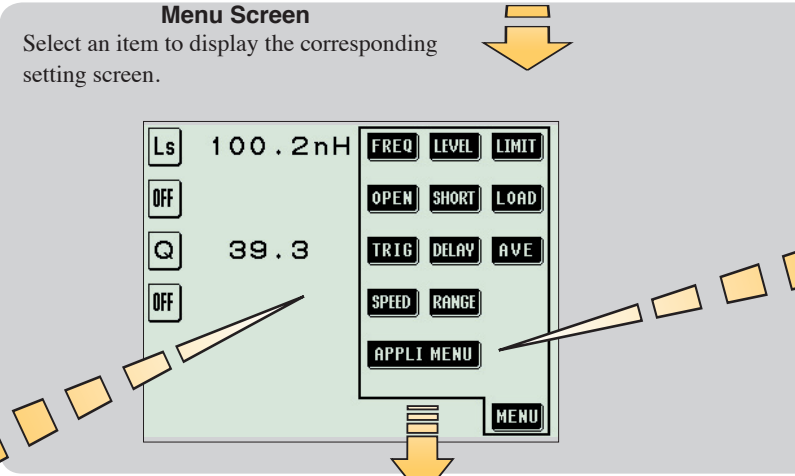

### Menu Screen

Select an item to display the corresponding setting screen.

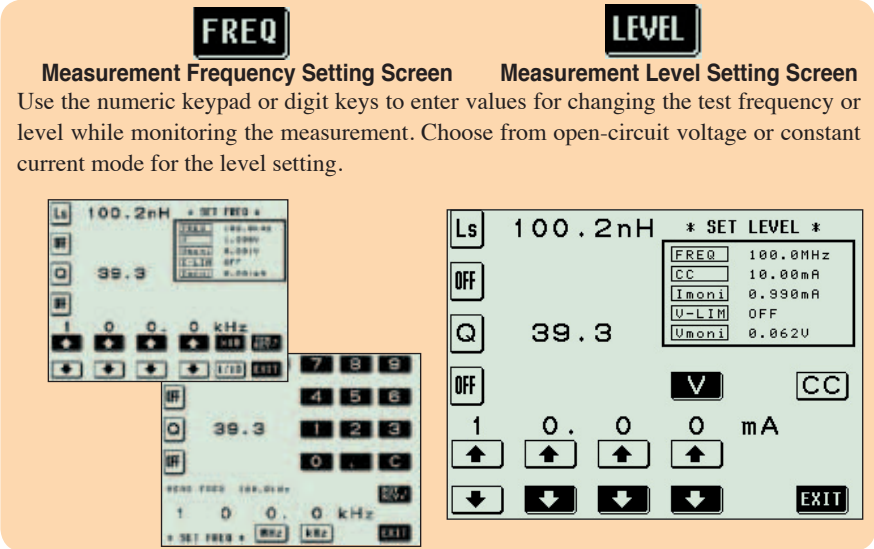

### FREQ

#### Measurement Frequency Setting Screen

Use the numeric keypad or digit keys to enter values for changing the test frequency or level while monitoring the measurement. Choose from open-circuit voltage or constant current mode for the level setting.

### LEVEL

#### Measurement Level Setting Screen

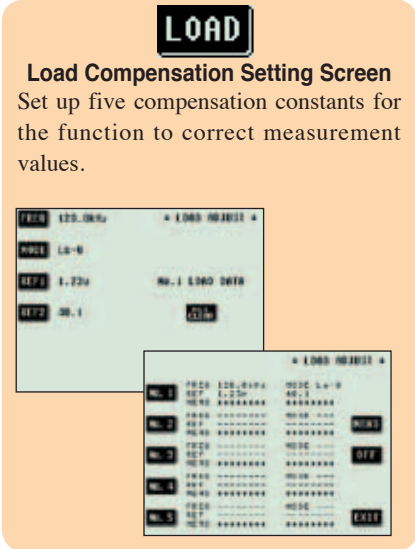

### LOAD

#### Load Compensation Setting Screen

Set up five compensation constants for the function to correct measurement values.



# Multiple Functions for a Broad Range of Applications

**COMP ON** **Comparator**

Compare two measurement items using the Comparator function. Input can be either the absolute value, percentage of standard value or its deviation percentage ( $\Delta\%$ ).

COMP MODE  $\rightarrow$  ABS  
ABS  $\Delta\%$   $\%$

\* SET COMP LIMIT \*

\* SET HI LIMIT \*

**BIN ON** **BIN (Classification) Measurement**

Classify 2 measurement items in up to 10 categories.

LS: % Q: ABS \* BIN LIST \*

BIN1 HI OFF OFF  
LO OFF OFF

BIN2 HI OFF OFF  
LO OFF OFF

BIN3 HI OFF OFF  
LO OFF OFF

BIN4 HI OFF OFF  
LO OFF OFF

BIN5 HI OFF OFF  
LO OFF OFF

BIN6 HI OFF OFF  
LO OFF OFF

BIN7 HI OFF OFF  
LO OFF OFF

BIN8 HI OFF OFF  
LO OFF OFF

BIN9 HI OFF OFF  
LO OFF OFF

BIN10 HI OFF OFF  
LO OFF OFF

\* SET HI LIMIT \*

**Application Setting Screen**

APPLICATION MENU

COMP ON BIN ON CONT MEAS

SCALE ON PANEL LOAD PANEL SAVE

RES T DIGIT

DI INTER FACE

EXIT

\* SELECT MENU \*

**CONT MEAS** **Continuous Measurements**

Measurement conditions saved by the Panel Save function can be used to continuously measure up to five conditions per page.

No. 6 ON/OFF TEST1  
Cs-D 200.0kHz COMP

No. 7 ON/OFF \*\*\* NO USE \*\*\*

No. 8 ON/OFF TEST3  
Cs-D 1

No. 9 ON/OFF TEST5  
Cs-D 1

\* CONTINUOUS MEAS \*

MANU TRIG EXIT

**SCALE ON** **Scaling**

Set constants a and b to apply compensation to measurement values.

SCALE EQUATION  
 $Z_{comp} = a + Z + b$

a b

\* SET SCALE a \*

**DIGIT** **Numeric Digit Display**

The number of significant digits of measured values of each parameter can be set to three, four or five digits.

PAR1 4 PAR1

PAR2 4 PAR2

PAR3 4 PAR3

PAR4 4 PAR4

\* SET No. OF DIGITS \*

**Zoom Display**

Enlarge the display of measurement data and comparator results.

MANU TRIG EXIT



# High Speed Testing of Chip Inductors and Magnetic Heads in Research and Development

## 3535 Specifications

<b>Measurement Items</b>	: Z (impedance), Y (admittance), Rs (series-equivalent resistance, ESR), Rp (parallel-equivalent resistance), G (conductivity), X (reactance), B (susceptance), $\theta$ (phase angle), Ls (series-equivalent inductance), Lp (parallel-equivalent inductance), Cs (series-equivalent capacitance), Cp (parallel-equivalent capacitance), Q (Q factor), D (loss constant $\tan\delta$ )	<b>Classification (BIN) Measurement</b>	: Ranks two measurement items into ten classifications.
<b>Measurement Frequency</b>	: Frequency Range: 100 kHz to 120 MHz Setting Resolution: Four digits (by front panel setting)* 100.0 kHz to 1.000 MHz: 100-Hz steps 1.000 MHz to 10.00 MHz: 1-kHz steps 10.00 MHz to 100.0 MHz: 10-kHz steps 100.0 MHz to 120.0 MHz: 100-kHz steps *1-Hz resolution with GP-IB or RS-232C interface Frequency Accuracy: less than $\pm 0.005\%$ of setting value	<b>Correlation Compensation Function</b>	: Constants a and b are entered to compensate displayed values. [Compensated value] = a $\times$ [measurement value] + b
<b>Output Impedance:</b>	50 $\pm$ 10 $\Omega$ (at 100 kHz)	<b>Panel Save and Load</b>	: Memory Capacity: 30 Sets Load Method: Front panel key operation, External I/O connector, GP-IB, RS-232C
<b>Measurement Signal Level</b>	: Open-terminal voltage (V) mode Level Range: 5 mV to 1 V, 20 mA max. (up to 10.00 MHz) 5 mV to 500 mV, 10 mA max. (above 10.01 MHz) Setting Resolution: 1mV steps Setting Accuracy: $\pm(5\% + 5 \text{ mV}) \times (2 + \log f)$ where f is in MHz Constant Current (CC) mode Level Range: 200 $\mu$ A to 20 mA: 1 V max. (up to 10.00 MHz) 200 $\mu$ A to 10 mA: 0.5 V max. (above 10.01 MHz) Setting Resolution: 10 $\mu$ A steps Setting Accuracy: $\pm(10\% + 50 \mu\text{A}) \times (2 + \log f)$ where f is in MHz	<b>Measurement Value Storage</b>	: Memory Capacity: Up to 200 values Measurement values are stored in the main unit and transferred as a batch.
<b>Monitor Function</b>	: Monitor Voltage: 0.000 to 1.000 V Monitor Current: 0.000 to 20.00 mA	<b>Zoom Display Function</b>	: Enlarge the display of measurement data and comparator results.
<b>Limit Function</b>	: Current Limit (during V setting): 0.20 to 20.00 mA Voltage Limit (during CC setting): 0.005 to 1.000 V	<b>Continuous Measurements</b>	: Measurements are made continuously per conditions saved on the screen.
<b>Measurement Time</b>	: 6 $\pm$ 1 ms (nominal) Actual time depends on measurement conditions, such as measurement speed and averaging.	<b>Audible Beeper</b>	: Beeping can be set ON/OFF for key entry and comparator results (IN or NG).
<b>Measurement Speed</b>	: FAST, NORMAL, SLOW and SLOW2	<b>Numerical Display Digit Setting Function</b>	: Measurement values can be set to display as 3, 4 or 5 digits. Available settings depend on the parameter.
<b>Average</b>	: OFF, 2, 4, 8, 16, 32 and 64	<b>Display Setting Functions</b>	: Backlight and voltage/current monitor display can be set ON/OFF. Note: when the backlight is off, display refresh is disabled (during high-speed measurement).
<b>Trigger Function</b>	: Internal and external trigger sources can be selected. Trigger Delay function: 0.01 to 9.99 s with 0.01 s resolution	<b>Printer Functions</b>	: Hard copy printout of measurement values and screens. Note: requires 9442 and 9444
<b>Load Compensation Function</b>	: Measure a standard component to establish a compensation value for subsequent measurements.	<b>Interfaces</b>	: GP-IB, RS-232C and EXT I/O (standard)
<b>Key Lock Function</b>	: Temporarily disable touch panel operation using rear panel switch.	<b>Operating Temperature and Humidity</b>	: 10 to 40°C, 80% rh or less, no condensation
<b>Comparator</b>	: Compares two measurement items. Input either the absolute value, percentage of standard value or its deviation percentage ( $\Delta\%$ ). Note: for $\Delta\%$ , the measurement value is displayed as the percentage of deviation from the standard value.	<b>Storage Temperature and Humidity</b>	: -10 to 55°C, 80% rh or less, no condensation
		<b>Operating Environment</b>	: Indoors, up to 2000 m ASL
		<b>Power</b>	: 100 to 240 VAC, 50/60 Hz
		<b>Maximum Rated Power</b>	: 50 VA
		<b>Dimensions and Mass</b>	: Approx. 360W $\times$ 130H $\times$ 360D mm, 8.3 kg
		<b>Conforming Standards</b>	: EMC: EN61326:1997+A1:1998+A2:2001 EN61000-3-2:2000 EN61000-3-3:1995+A1:2001 Safety: EN61010-1:2001 Pollution Degree 2

## Measurement Accuracy and Range

Accuracy is calculated using Z and  $\theta$ , and other parameters are calculated from these.

Z Accuracy: calculated from the following formula

$$\text{Accuracy [\%]} = \text{basic accuracy} \times \text{frequency constant} \times \text{level constant} \times \text{measurement speed} \\ \text{constant} \times \text{cable length constant} \times \text{temperature constant}$$

$\theta$  Accuracy: calculated from the following formula

$$\text{Accuracy [degrees]} = \text{Z accuracy} \times 0.6$$

### Basic Accuracy

Measurement Range	HEAD AMP UNIT 9700-10			Upper end of range Basic accuracy = $A + B \times \left( \frac{Z_m \times 10^{-1}}{\text{range}} \right)$  Lower end of range Basic accuracy = $A + B \times \left( \frac{\text{range}}{Z_m \times 10^{-1}} \right)$  $Z_m$ = measurement value
	1 k $\Omega$ range	10 k $\Omega$ range	100 k $\Omega$ range	
10 k $\Omega$ to 300 k $\Omega$			A=2.00 B=0.20	
1 k $\Omega$ to 20 k $\Omega$		A=1.00 B=0.10		
100 $\Omega$ to 2 k $\Omega$	A=0.50 B=0.10			
100 m $\Omega$ to 100 $\Omega$	A=0.50 B=0.10			

### Frequency Constant

$\log f + 2$  ( $f \leq 10$  MHz), where f is in MHz  
 $10 \times \log f - 7$  ( $f > 10$  MHz), where f is in MHz

### Cable Length Constant

1 (0m)  
 2 (2m, 9678)

### Measurement Speed Constant

5 + 150/V (FAST), where V is in mV  
 3 + 100/V (NORMAL), where V is in mV  
 1.5 + 30/V (SLOW), where V is in mV  
 1 (SLOW2)

### Level Constant

10 - 3  $\times$  log V, where V is in mV

### Temperature Constant

$1 + 0.11 |T [^\circ\text{C}] - 23 [^\circ\text{C}]|$

### [Measurement Range: Reference Value]

	1 k $\Omega$ range	10 k $\Omega$ range	100 k $\Omega$ range
Z $\cdot$ R*	100 $\Omega$ to 2 k $\Omega$	1k $\Omega$ to 20 k $\Omega$	10 k $\Omega$ to 300 k $\Omega$
C*	0.66 pF to 15.9 $\mu$ F	0.066 pF to 1.59 nF	4.4 fF to 159 pF
L*	0.133 nH to 3.18 mH	1.33 $\mu$ H to 31.8 mH	13.3 $\mu$ H to 477mH
$\theta$	-180.00 $^\circ$ to 180.00 $^\circ$		

\*Ranges for R, C, and L measurement are based on the data calculated from the Z measurement range, and do not represent the guaranteed measurement ranges.

### Method of Acquiring Measurement Accuracy

Obtaining the basic accuracy of a capacitor. (Cs=100pF)

Measurement value: Z = 159.33,  
 $\theta = -87.33^\circ$  when measuring with the following conditions using 1 k $\Omega$  range.

- Measurement Frequency: 10 MHz
- Measurement Speed: SLOW2
- Measurement Signal Level: 500 mV
- Cable Length: 0 m
- Temperature: 24 $^\circ$ C

1. Acquire Z constants A and B from the basic accuracy table, and calculate the basic accuracy of Z.

2. Acquire the other constants from the measurement conditions.

3. Acquire the accuracy of Z.

4. Calculate the basic accuracy of  $\theta$  from the basic accuracy of Z.

5. The range of possible values for Z and  $\theta$  is acquired from the basic accuracy. The absolute value of  $\theta$  is used.

6. The range of possible values for Cs is acquired from the range of Z and  $\theta$ .  
 $X = Z \sin \theta$ ,  $C_s = 1 / \omega X$

From the basic accuracy table, the constants A and B are A = 0.50 and B = 0.10

$$\text{Z basic accuracy} = 0.50 + 0.10 \times \left( \frac{159.33 \times 10}{1000} - 1 \right) = \pm 0.559\%$$

$$\text{Frequency constant} = \log(10) + 2 = 3$$

$$\text{Level constant} = 10 - 3 \times \log(500) = 1.903$$

$$\text{Measurement Speed constant} = 1$$

$$\text{Cable Length constant} = 1$$

$$\text{Temperature constant} = 1 + 0.1 \times |24 - 23| = 1.1$$

$$\text{Z accuracy} = 0.559 \times 3 \times 1.903 \times 1 \times 1 \times 1.1 = \pm 3.510\%$$

$$\theta \text{ accuracy} = 3.510 \times 0.6 = \pm 2.106^\circ$$

$$Z_{\min} = 159.33 \times (1 - 3.510 / 100) = 153.74 \Omega$$

$$Z_{\max} = 159.33 \times (1 + 3.510 / 100) = 164.92 \Omega$$

$$\theta_{\min} = 87.33 - 2.106 = 85.224^\circ$$

$$\theta_{\max} = 87.33 + 2.106 = 89.436^\circ$$

$$C_{s\min} = 1 \div (\omega \times Z_{\max} \times \sin \theta_{\max}) = 96.509 \text{ pF} \dots 3.491\%$$

$$C_{s\max} = 1 \div (\omega \times Z_{\min} \times \sin \theta_{\min}) = 103.883 \text{ pF} \dots 3.883\%$$

$$\omega = 2 \times \pi \times f, \text{ where } f \text{ is the measurement frequency in Hz}$$

Therefore, the basic accuracy of Cs is -3.491 to 3.883%.

## Options

Head Amp Unit must be factory adjusted for dedicated use with the 3535 before delivery.

**HEAD AMP UNIT 9700-10**  
Measurement Range: 100 mΩ to 300 kΩ(3 ranges)

**CONNECTION CABLE 9678**  
Cable Length: 2m

**SMD TEST FIXTURE 9677**  
Operating Frequency : DC to 120 MHz  
Measurable Object Size : 3.5 ±0.5 mm  
Dimensions : Approx. 103W × 37.1H × 47.6D mm  
Mass : Approx. 135 g  
*\*Please note that use of the 9677 with Model 3535 will NOT comply with CE mark requirements.*

**SMD TEST FIXTURE 9699**  
Operating Frequency : DC to 120 MHz  
Measurable Object Size :  
Width: 1.0 to 4.0mm; Height: less than 1.5mm  
Dimensions : Approx. 100.5W×28.6H×40.0Dmm  
Mass : Approx. 125 g  
For testing components with electrodes on the bottom

**SMD TEST FIXTURE (direct contact type)**

**PRINTER 9442**  
Printing Method : Thermal serial dot printer  
Paper Width / Print Speed : 112 mm / 52.5 cps  
Power Supply : AC Adapter 9443 or supplied NiMH battery (prints 3000 lines after full charge by 9443)  
Dimensions : Approx. 160W × 66.5H × 170D mm  
Mass : Approx. 580 g

Note: the Connection Cable 9444 and AC Adapter are required to connect the Printer 9442.

## LCR HiTESTER 3535

The Head Amp and Test Fixtures are not supplied with the unit.  
Please order the appropriate options for your application.

### ● Options

HEAD AMP UNIT 9700-10

SMD TEST FIXTURE 9677

SMD TEST FIXTURE 9699

CONNECTION CABLE 9678

RS-232C CABLE (9pin-9pin/cross/1.8m) 9637

RS-232C CABLE (9pin-25pin/cross/1.8m) 9638

Head Amp Unit must be factory adjusted for dedicated use with the 3535 before delivery.

GP-IB CONNECTION CABLE (2 m) 9151-02

PRINTER 9442

AC ADAPTER (for 9442, EU) 9443-02

CONNECTION CABLE (for 9442) 9444

RECORDING PAPER (for 9442 / 25 m, 10 rolls) 1196

Note: Company names and Product names appearing in this catalog are trademarks or registered trademarks of various companies.

# HIOKI

HIOKI E. E. CORPORATION

#### HEADQUARTERS:

81 Koizumi, Ueda, Nagano, 386-1192, Japan  
TEL +81-268-28-0562 FAX +81-268-28-0568  
http://www.hioki.com / E-mail: os-com@hioki.co.jp

#### HIOKI USA CORPORATION:

TEL +1-609-409-9109 FAX +1-609-409-9108  
http://www.hiokiusa.com / E-mail: hioki@hiokiusa.com

#### HIOKI (Shanghai) SALES & TRADING CO., LTD.:

TEL +86-21-63910090 FAX +86-21-63910360  
http://www.hioki.cn / E-mail: info@hioki.com.cn

#### HIOKI INDIA PRIVATE LIMITED:

TEL +91-124-6590210 FAX +91-124-6460113  
E-mail: hioki@hioki.in

#### HIOKI SINGAPORE PTE. LTD.:

TEL +65-6634-7677 FAX +65-6634-7477  
E-mail: info-sg@hioki.com.sg

#### HIOKI KOREA CO., LTD.:

TEL +82-42-936-1281 FAX +82-42-936-1284  
E-mail: info-kr@hioki.co.jp

DISTRIBUTED BY