



Fully Integrate into High-Speed, Multi-channel Measurement Systems

Multi-channel

Up to 32 + 22 channels (MR8740)

The MR8740 uses a two-block internal architecture, essentially giving it the capabilities of two MEMORY HiCORDERs.

Up to 16 channels (MR8741)

High-speed isolated measurement

20 MS/s isolated sampling

Simultaneous 20M sampling within the same block

DVM UNIT MR8990

Digital Voltage Meter

Measure minute changes in voltage at a high level of precision. Simultaneous measurement of all channels--rather than scanner-type measurement--dramatically reduces cycle times.

Systems Integration

Ideal for rack-mounting

Height of 4U (180 mm) or less
MR8740: 177 (H) × 426 (W) mm
MR8741: 160 (H) × 350 (W) mm

Are you having problems with multi-channel measurement or testing?

“We're using multiple DMM units with a scanner to switch inputs. Measurement takes too long...”

Reduced cycle times

“We need to perform many different types of measurements on a large number of channels.”

Measure across multiple channels at the same time

“We're using multiple measuring instruments, and it's hard to control them all. The wiring is a mess...”

Simplified systems

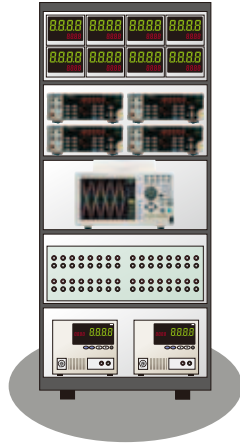

“We can't embed our oscilloscope, so we use it on a shelf. Our setup would be a lot sleeker if we could fit it in.”

Rack-mountable design

“Tall, large racks are dangerous in a production setting. I wonder if our setup can be made smaller...”

Space-saving design

“I wish we could make measurements faster and at a higher level of precision.”

High-speed, high-precision performance



Solve these issues with the MR8740/MR8741 Memory HiCorder.

A single-instrument solution for measuring multiple signal types and channels featuring rack-style measurement units that can be selected freely according to the target application

High precision and high resolution

DIGITAL VOLTAGE METER

DVM UNIT MR8990

The MR8990 can measure even minute voltages previously measured with a DMM. The MR8990 can capture minute voltage fluctuations as waveforms.



Features

High resolution: 24bit, 6.5-digit display

Thanks to a resolution of 0.1 μ V, the MR8990 can measure even minute fluctuations in the output voltage of sensors and other equipment.

High accuracy: $\pm 0.01\%$ rdg. $\pm 0.0025\%$ f.s.

The MR8990 performs measurements at a high precision of $\pm 0.01\%$ rdg. $\pm 0.0025\%$ f.s. and at speeds of up to 500 samples per second.

Max. allowable input: DC 500 V

The MR8990 can accommodate input ranging from minute to high voltages.

High input resistance

5mV/DIV to 500mV/DIV range: 100 M Ω or greater
5V/DIV to 50V/DIV range : 10 M Ω $\pm 5\%$

Input Unit Comparison Chart (Input Voltage and Sampling Speed)

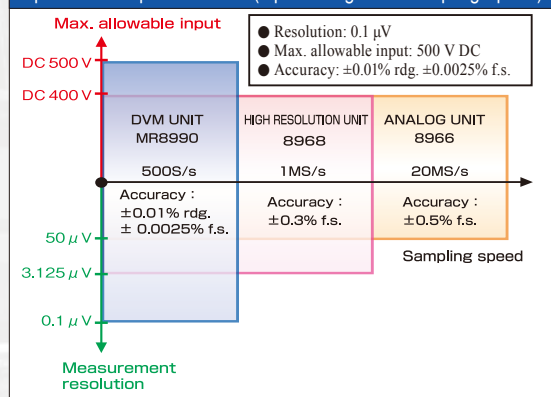

Extensive selection of Measurement or Output units

Thanks to a unit-based architecture that can accommodate voltage, current, temperature, frequency, distortion, measurement, and waveform output, the MR8740/MR8741 is a single-instrument solution for measuring multiple parameters. As a bonus, the ability to simultaneously record different signals on multiple channels cuts down on measurement times.

Ideal for rack-mounting

The MR8740/MR8741 ship standard with EIA standard-compliant rack-mounting hardware. The instruments also support JIS standard racks. Please contact HIOKI for more information.

The MR8740 is a rack-mountable instrument that can measure up to (32 + 22) channels. It uses a two-block architecture (32ch + 22ch), essentially giving it the capabilities of two Memory HiCorders.

MR8740 32ch + 22ch model

- Accommodates up to 27 measurement units.
- Two-block architecture (Block I: 16 units; block II: 11 units)
- Standard support for 16 logic channels

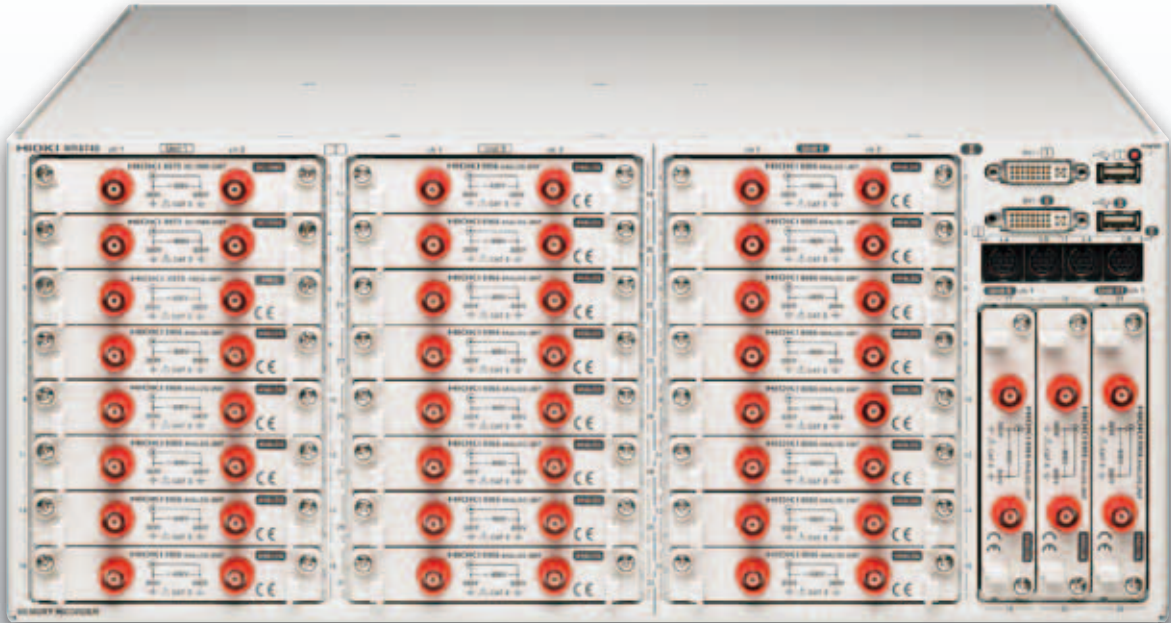

Support for multi-channel measurement of up to 54 channels. Switchable inter-block trigger synchronization

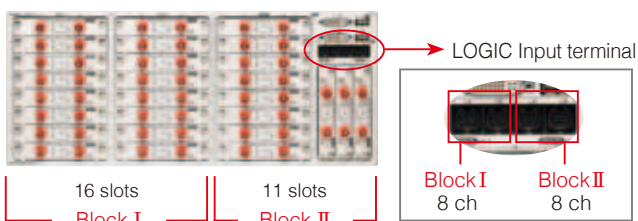

Block I : Analog 32ch, Logic 8ch
Block II : Analog 22ch, Logic 8ch

(There may be a lag of up to 1 μ s or 3 samples between blocks I and II.)

Example: Multi-channel DMM (DC V only)



By switching from a bench-type DMM to a DVM unit, you can cut down on the amount of space taken up by measuring instruments. With no need to control multiple instruments, you can also simplify your system.

Independent block operation. Support for applications using different functions

Since blocks I (32 channels) and II (22 channels) perform measurements independently, it is possible to set different function and sampling speeds for each block. Operations such as starting measurement are performed separately by each block, and different measurement data files are used by each block.

For example...

Block I : MEMORY function, 20MS/s
Block II : FFT function, 20MS/s

A single instrument supports a variety of measurements, expanding the range of applications in which the device can be used.



[Rear] LAN (100BASE-TX) and USB (type A, for USB flash memory or a mouse) connectors are standard on the rear of the instrument. The power inlet and power switch are also located here.

The MR8741 is a bench-top instrument that delivers affordable measurement performance. It features area judgment functionality and external control terminals.

MR8741 16ch model

- Accommodates up to 8 measurement units.
- Standard support for 16 logic channels
- Area judgment function and external control terminals

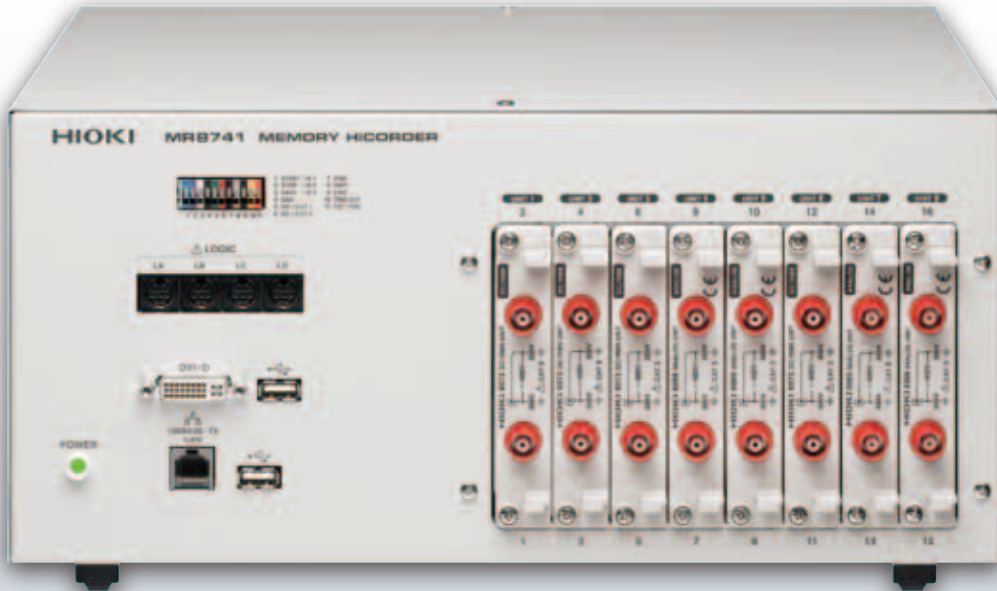

[Rear] A vent (fan), power inlet, and power switch are located on the rear of the instrument.

[Front panel]

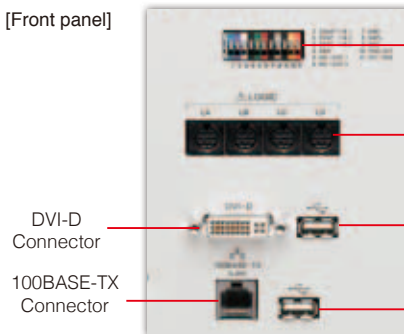

External control terminals

LOGIC terminals

DVI-D Connector

100BASE-TX Connector

USB Connector

(Type A, for USB memory stick or mouse)

Use as a multi-channel WAVE COMPARATOR.

High-speed waveform judgment function

The MR8741's waveform judgment function, which monitors whether a target waveform has diverged from an area with a safe margin, makes it easy to measure signal waveforms for which it can otherwise be difficult to make pass/fail judgments. The instrument can measure waveforms on multiple channels at the high speed of 20 MS/s, providing immediate pass/fail judgments in maintenance and production line applications.

When using a time-axis range slower than 100msec/div, measured waveforms can be compared in near real-time, enabling you to detect failures on the spot. Production can be halted in time to minimize resource waste.

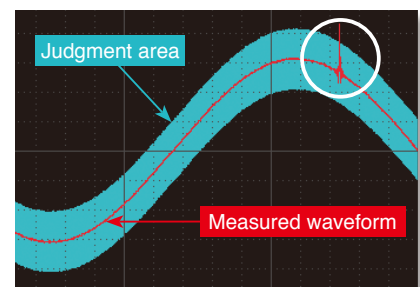

Compare captured waveform with reference area

Setting the waveform evaluation

[OUT] Return NG if any part of the waveform leaves the evaluation area.
[ALL OUT] Return NG if the entire waveform leaves the evaluation area.

Setting the GO/NG stop mode

[GO] Stop recording on GO result.
[NG] Stop recording on NG result.
[GO] Stop recording on GO or NG result.

Convenient functions

Display and mouse connectivity

Measure without using a PC.

By connecting a display and mouse to the MR8740/MR8741, you can display waveforms and operate the instrument with a mouse.

The monitor display screen uses the same layout as the MR8847 Memory HiCorder series display. A mouse can be used to operate and configure the instrument, providing a user experience that approximates use of a keyboard. (Display and mouse not included.)

Connect a display and mouse to enable standalone use.

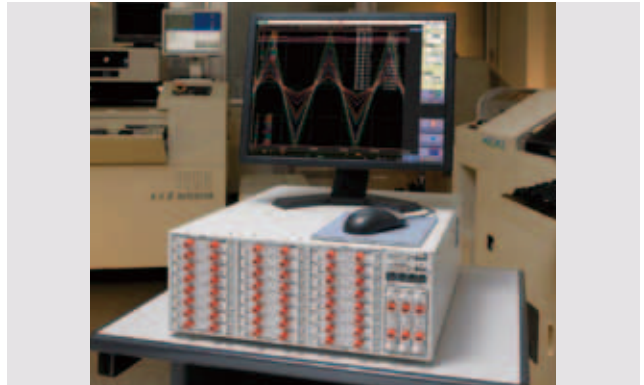

X-Y wave comparator MR8741 only

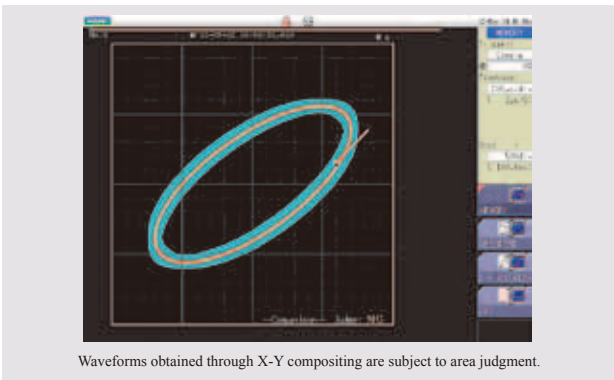

Waveforms obtained through X-Y compositing are subject to area judgment.

The MR8741 includes functionality for judging X-Y waveforms. Waveforms measured using the memory function and created with X-Y compositing are subject to area judgment.

The X-Y waveforms captured from these and many other applications can be tested against reference waveforms automatically:

- Alteration and pressure at press machines
- Pump pressure and flow

Value monitor (DMM display)

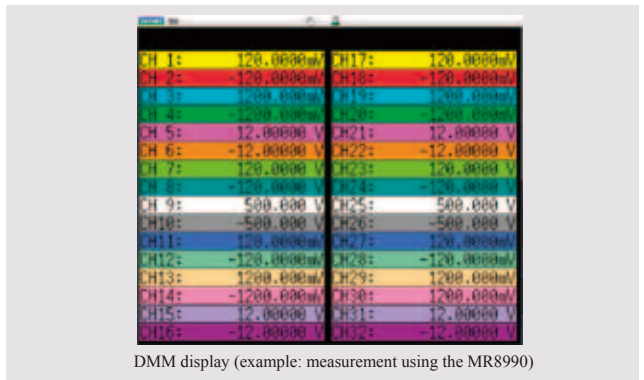

DMM display (example: measurement using the MR8990)

Input values can be monitored numerically in the manner of a digital multimeter (DMM).

Numerical calculation function

Calculate parameter values from measured waveform

20 different built-in calculation types including effective (rms) value, peak value, and maximum value.

Multiple channels can be measured and judged at once, minimizing cycle times. Inter-channel calculations can also be performed at high speed by means of internal processing, and the results can be transferred to a computer.

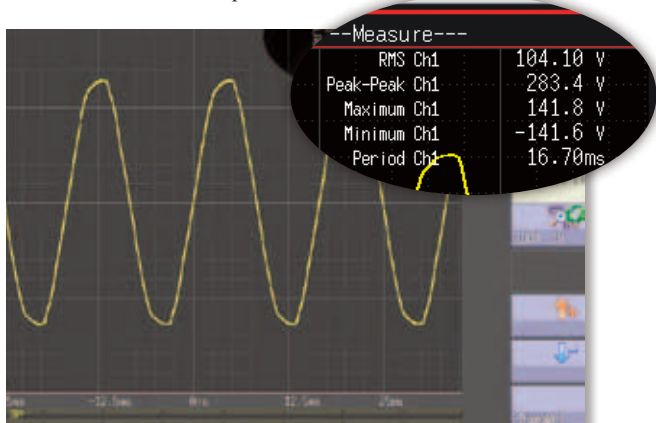

Numerical calculation results can be shown on waveform display

Numerical calculation settings

Evaluation settings

Parameter	Judge	Lower	Upper
Parameter 1	Off		
Parameter 2	On	-1.0000	1.0000
Parameter 3	Off		
Parameter 4	Off		

HIOKI Numerical Calc Settings

- Numerical Calc: On
- Print Calc Result: Off
- Calc Area: Whole Wave
- Save Calc Result: Off
- Stop Mode: GO&NG

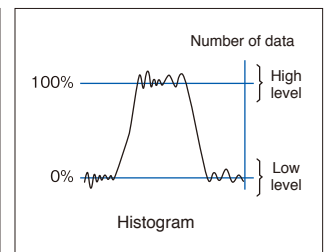
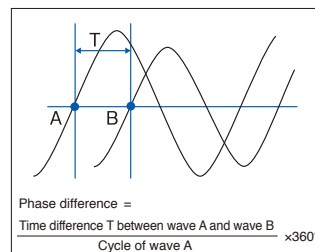

Signal Input and Output

The right module for your measurement needs

Inverter / UPS Test

- Operation testing and evaluation during load fluctuation
- Confirmation of UPS switching

Recommended units	ANALOG UNIT 8966
	LOGIC UNIT 8973
	CURRENT UNIT 8971

Perfect for inverter and UPS evaluation / start-up tests. Record using both logic (control signals) and analog (primary/secondary voltage or current for a UPS or inverter).



UPS



Inverter

Power Monitor and Logger

- Identify power fluctuations when power supply is turned ON/OFF and during load fluctuations
- Long-term fluctuations in power

Recommended units	ANALOG UNIT 8966
	HIGH RESOLUTION UNIT 8968
	FREQ UNIT 8970

Load the analog output for the rms (instant power / voltage / current, etc.) calculated by the power analyzer, or import the waveform output from the power analyzer to observe data for long-term tests or irregular waveforms.

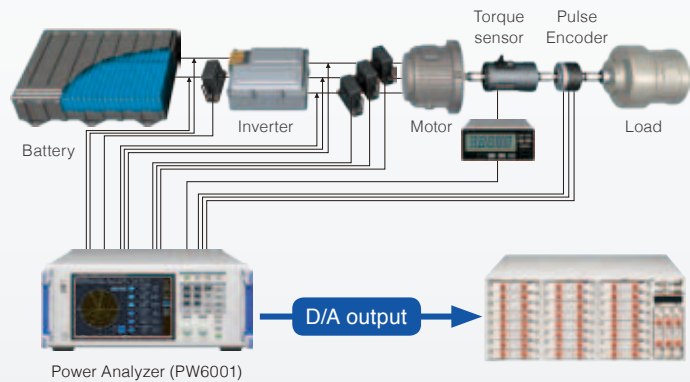

Power Analyzer (PW6001)

Control Simulation

- Generate simulated output of each type of sensor signal
- Fluctuating simulated output for 12 V DC car batteries

Recommended units	ARBITRARY WAVEFORM GENERATOR UNIT U8793
	WAVEFORM GENERATOR UNIT MR8490
	PULSE GENERATOR UNIT MR8791

Use actual waveforms to perform testing on control boards, such as for engine control, airbags, brake systems, power steering, and active suspension. This allows efficient simulation of actual waveforms obtained from cars.



Perfect for control testing of automobiles, high speed trains, and traditional trains

13 units to choose from

Generation	Voltage	DC voltage	Generation	Pulse	Voltage
ARBITRARY WAVEFORM GENERATOR UNIT U8793	HIGH VOLTAGE UNIT U8974	DIGITAL VOLTMETER UNIT MR8990	WAVEFORM GENERATOR UNIT MR8790	PULSE GENERATOR UNIT MR8791	ANALOG UNIT 8966
No. of channels: 2 Arbitrary waveform output	Measurement resolution: 16-bit 1/1600 of measurement range	Measurement resolution: 24-bit 1/50 000 of measurement range	No. of channels: 4 Waveform output	No. of channels: 8 Pulse output	Measurement resolution: 12-bit 20 MS/s high-speed sampling
• Output frequency range 10m Hz to 100 kHz • Max. output: 15 V	• High voltage • Commercial power supply (primary/secondary) • Power equipment characteristics testing	• Multi-channel • Minute sensor voltage • EV battery voltage	• DC output: -10 V to 10 V • Sine wave output 10 mHz to 20 kHz	• Pulse output 0.1 Hz to 20 kHz • Pattern output	• Various amps • Transducers • Sensors • Industrial meters

Abundant modules

Hioki has added new high-performance modules in response to overwhelming demand.

The Memory HiCorder now supports a wide variety of measurements.

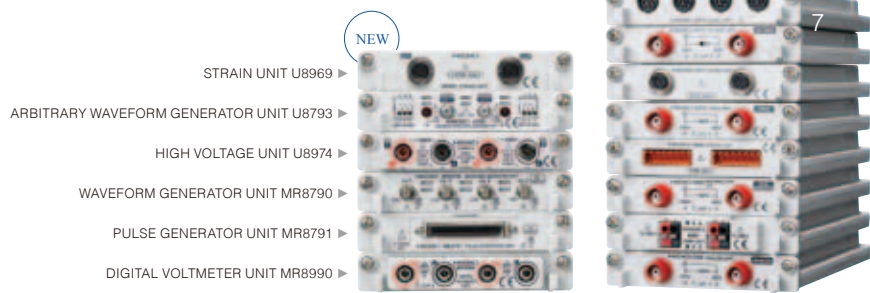

Output and record results seamlessly

Just one MEMORY HiCORDER gives you a function generator mode, arbitrary waveform generator mode, and waveform measurement mode. This makes it easy to observe waveforms while varying test conditions, such as changing the signal's amplitude and frequency and programming various waveforms to output in order.

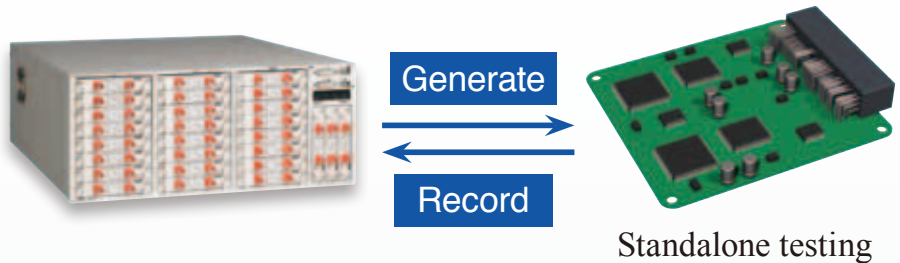

Output recorded waveforms without modification

For example, you could output actual waveforms recorded from a car without modification, and then use them for standalone testing. You can also generate isolated output of up to 15 V without a generator or amplifier, which is traditionally necessary in order to generate output while varying the signal's amplitude and frequency.

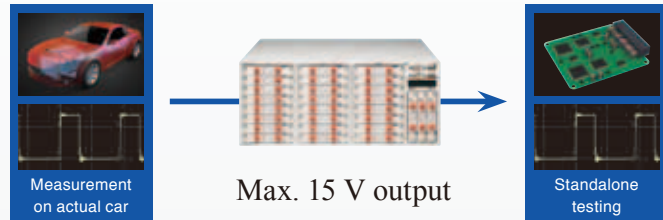

Process actual waveforms for reproducibility testing

Process and calculate signals recorded with the MEMORY HiCORDER and output the arbitrary waveforms that you create.

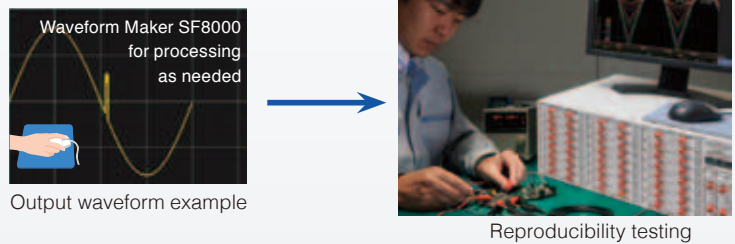

Waveform Maker Software included

After you install the included SF8000 Waveform Maker software on your computer, you can create waveforms easily by either entering them directly or by entering the functions behind them. You can also quickly add noise and multiply waveforms.

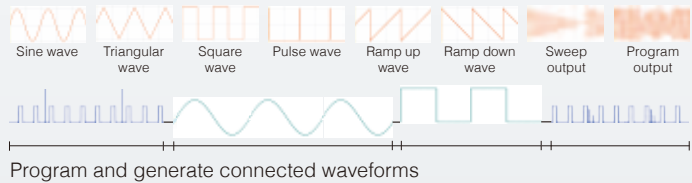

1000 V DC, 700 V AC high-voltage direct input

Since you can directly input up to 1000 V DC and 700 V AC, a differential probe is no longer necessary. Maximum rated voltage to ground is 1000 V for CAT III and 600 V for CAT IV environments.

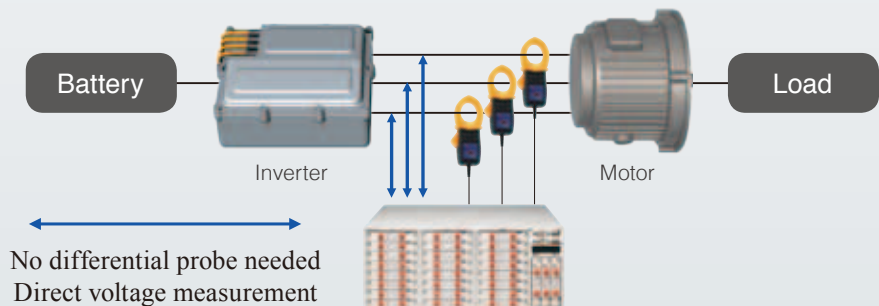

Temperature	Voltage	Distortion	Frequency, RPM	Current	Voltage	Contact
TEMP UNIT 8967 	HIGH RESOLUTION UNIT 8968 	STRAIN UNIT U8969 	FREQ UNIT 8970 	CURRENT UNIT 8971 	DC/RMS UNIT 8972 	LOGIC UNIT 8973
Measurement resolution: 16-bit 1/1000 of measurement range	Measurement resolution: 16-bit 1/1600 of measurement range	Measurement resolution: 16-bit 1/1250 of measurement range	Measurement resolution: 16-bit 1/2000 of measurement range	Measurement resolution: 12-bit Clamp sensor direct connection	Measurement resolution: 12-bit RMS measurement	No. of channels: 16 Observation of control signal
<ul style="list-style-type: none"> Thermocouple K, J, E, T, N, R, S, B, W 	<ul style="list-style-type: none"> Supply voltage Primary / secondary inverter voltage Motor voltage, etc. 	<ul style="list-style-type: none"> Strain gauge converter Dynamic strain * Vibration Pressure * Acceleration Weight, etc. 	<ul style="list-style-type: none"> Encoder Rotating pulse 	<ul style="list-style-type: none"> Supply current Inverter current Motor current, etc. 	<ul style="list-style-type: none"> Supply voltage Primary / secondary inverter voltage Motor voltage, etc. 	<ul style="list-style-type: none"> Voltage / non-voltage contacts Relay signals AC / DC signals

Optional Specifications (sold separately)

Dimensions and mass: approx. 106 mm (4.17 in) W × 19.8 mm (0.78 in) H × 196.5 mm (7.74 in) D, approx. 250 g (8.8 oz)
Accessories: None



ANALOG UNIT 8966 (Accuracy at 23 ±5°C/73 ±9°F, 20 to 80% rh after 30 minutes of warm-up time and zero adjustment; Accuracy guaranteed for 1 year, Post-adjustment accuracy guaranteed for 1 year)	
Measurement functions	Number of channels: 2, for voltage measurement
Input terminals	Isolated BNC connector (input impedance 1 MΩ, input capacitance 30 pF), Max. rated voltage to ground: 300 V AC or DC (with input isolated from the main unit, the maximum voltage that can be applied between input channel and chassis, and between input channels without damage)
Measurement range	5 mV to 20 V/div, 12 ranges, full scale: 20 div, AC voltage for possible measurement/display using the memory function: 280 V rms, Low-pass filter: 5/50/500 Hz, 5 k/50 k/500 kHz
Measurement resolution	1/100 of range (using 12-bit A/D conversion)
Maximum sampling rate	20 MS/s (simultaneous sampling in 2 channels)
Measurement accuracy	±0.5% of full scale (with filter 5 Hz, zero position accuracy included)
Frequency characteristics	DC to 5 MHz -3 dB, (with AC coupling: 7 Hz to 5 MHz -3 dB)
Input coupling	AC/DC/GND
Maximum input voltage	400 V DC (maximum voltage that can be applied between input connectors without damage)

Dimensions and mass: approx. 106 mm (4.17 in) W × 19.8 mm (0.78 in) H × 204.5 mm (8.05 in) D, approx. 240 g (8.5 oz)
Accessories: Ferrite clamp × 2



TEMP UNIT 8967 (Accuracy at 23 ±5°C/73 ±9°F, 20 to 80% rh after 30 minutes of warm-up time and zero adjustment; Accuracy guaranteed for 1 year, Post-adjustment accuracy guaranteed for 1 year)	
Measurement functions	Number of channels: 2, for temperature measurement with thermocouple (voltage measurement not available)
Input terminals	Thermocouple input: plug-in connector, Recommended wire diameter: single-wire, 0.14 to 1.5 mm ² , braided wire 0.14 to 1.0 mm ² (conductor wire diameter min. 0.18 mm), AWG 26 to 16 Input impedance: min. 5 MΩ (with line fault detection ON/OFF), Max. rated voltage to ground: 300 V AC or DC (with input isolated from the main unit, the maximum voltage that can be applied between input channel and chassis, and between input channels without damage)
Temperature measurement range	10°C (50°F)/div (-100°C to 200°C (-148°F to 392°F)), 50°C (122°F)/div (-200°C to 1000°C (-328°F to 1832°F)), 100°C (212°F)/div (-200°C to 2000°C (-328°F to 3632°F)), 3 ranges, full scale: 20 div, Measurement resolution: 1/1000 of measurement range (using 16-bit A/D conversion)
Thermocouple range (JIS C 1602-1995) (ASTM E-988-96)	K: -200°C to 1350°C (-328°F to 2462°F), J: -200°C to 1100°C (-328°F to 2012°F), E: -200°C to 800°C (-328°F to 1472°F), T: -200°C to 400°C (-328°F to 752°F), N: -200°C to 1300°C (-328°F to 2372°F), R: 0°C to 1700°C (32°F to 3092°F), S: 0°C to 1700°C (32°F to 3092°F), B: 400°C to 1800°C (752°F to 3272°F), W (WR5-26): 0°C to 2000°C (32°F to 3632°F), Reference junction compensation: internal/ external (switchable), Line fault detection ON/OFF possible
Data refresh rate	3 methods, Fast: 1.2 ms (digital filter OFF), Normal: 100 ms (digital filter 50/60 Hz), Slow: 500 ms (digital filter 10 Hz)
Measurement accuracy	Thermocouple K, J, E, T, N: ±0.1% of full scale ±1°C (±1.8°F) (±0.1% of full scale ±2°C (±3.6°F) at -200°C to 0°C (-328°F to 32°F)), Thermocouple R, S, B, W: ±0.1% of full scale ±3.5°C (±6.3°F) (at 0°C (32°F) to less than 400°C (752°F)); However, no accuracy guarantee of less than 400°C (752°F) for B, ±0.1% f.s. ±3°C (±5.4°F) (at 400°C (752°F) or more) Reference junction compensation accuracy: ±1.5°C (±2.7°F) (added to measurement accuracy with internal reference junction compensation)

Dimensions and mass: approx. 106 mm (4.17 in) W × 19.8 mm (0.78 in) H × 196.5 mm (7.74 in) D, approx. 250 g (8.8 oz)
Accessories: None



HIGH RESOLUTION UNIT 8968 (Accuracy at 23 ±5°C/73 ±9°F, 20 to 80% rh after 30 minutes of warm-up time and zero adjustment; Accuracy guaranteed for 1 year, Post-adjustment accuracy guaranteed for 1 year)	
Measurement functions	Number of channels: 2, for voltage measurement
Input terminals	Isolated BNC connector (input impedance 1 MΩ, input capacitance 30 pF), Max. rated voltage to ground: 300 V AC, DC (with input isolated from the unit, the maximum voltage that can be applied between input channel and chassis and between input channels without damage)
Measurement range	5 mV to 20 V/div, 12 ranges, full scale: 20 div, AC voltage for possible measurement/display using the memory function: 280 V rms, Low-pass filter: 5/50/500 Hz, 5k/50k Hz
Anti-aliasing filter	Integrated filter for suppressing aliasing distortion caused by FFT processing (automatic cutoff frequency setting/OFF)
Measurement resolution	1/1600 of measurement range (using 16-bit A/D conversion)
Maximum sampling rate	1 MS/s (simultaneous sampling in 2 channels)
Measurement accuracy	±0.3% of full scale (with filter 5 Hz, zero position accuracy included)
Frequency characteristics	DC to 100 kHz -3 dB (with AC coupling: 7 Hz to 100 kHz -3 dB)
Input coupling	AC/DC/GND
Maximum input voltage	400 V DC (maximum voltage that can be applied between input connectors without damage)

Dimensions and mass: approx. 106 mm (4.17 in) W × 19.8 mm (0.78 in) H × 196.5 mm (7.74 in) D, approx. 245 g (8.6 oz)
Accessories: Conversion cable L9769 × 2 (cable length 60 cm/1.97 ft)



STRAIN UNIT U8969 (Accuracy at 23 ±5°C/73 ±9°F, 80% rh or less, after 30 minutes of warm-up time and auto-balancing; Accuracy guaranteed for 1 year, Post-adjustment accuracy guaranteed for 1 year)	
Measurement functions	Number of channels: 2, for distortion measurement (electronic auto-balancing, balance adjustment range within ±10 000 μe or less)
Input terminals	NDIS connector EPRC07-R9FNDIS (via Conversion Cable L9769, NDIS connector PRC03-12A10-7M10.5) Max. rated voltage to ground: 30 V rms or 60 V DC (with input isolated from the unit, the maximum voltage that can be applied between input channel and chassis and between input channels without damage)
Suitable transducer	Strain gauge converter, Bridge impedance: 120 Ω to 1 kΩ, Bridge voltage: 2 V ±0.05 V, Gauge rate: 2.0
Measurement range	20 μe to 1000 μe/div, 6 ranges, full scale: 20 div, Low-pass filter: 5/10/100 Hz, 1 kHz
Measurement resolution	1/1250 of measurement range (using 16-bit A/D conversion)
Maximum sampling rate	200 kS/s (simultaneous sampling across 2 channels)
Measurement accuracy After auto-balancing	±0.5% f.s. ±4 μe (5 Hz filter ON)
Frequency characteristics	DC to 20 kHz +1/-3 dB

Dimensions and mass: approx. 106 mm (4.17 in) W × 19.8 mm (0.78 in) H × 196.5 mm (7.74 in) D, approx. 250 g (8.8 oz)
Accessories: None



FREQ UNIT 8970 (Accuracy at 23 ±5°C/73 ±9°F, 20 to 80% rh after 30 minutes of warm-up time; Accuracy guaranteed for 1 year, Post-adjustment accuracy guaranteed for 1 year)	
Measurement functions	Number of channels: 2, for voltage input based frequency measurement, rotation, power frequency, integration, pulse duty ratio, pulse width
Input terminals	Isolated BNC connector (input impedance 1 MΩ, input capacitance 30 pF), Max. rated voltage to ground: 300 V AC or DC (with input isolated from the main unit, the maximum voltage that can be applied between input channel and chassis, and between input channels without damage)
Frequency mode	Range: Between DC to 100 kHz (minimum pulse width 2 μs), 1 Hz/div to 5 kHz/div (full scale = 20 div), 8 settings Accuracy: ±0.1% f.s. (exclude 5 kHz/div), ±0.7% f.s. (at 5 kHz/div)
Rotation mode	Range: Between 0 to 2 million rotations/minute (minimum pulse width 2 μs), 100 (r/min)/div to 100 k (r/min)/div (full scale = 20 div), 7 settings Accuracy: ±0.1% f.s. (excluding 100 k (r/min)/div), ±0.7% f.s. (at 100 k (r/min)/div)
Power frequency mode	Range: 50 Hz (40 to 60 Hz), 60 Hz (50 to 70 Hz), 400 Hz (390 to 410 Hz) (full scale = 20 div), 3 settings Accuracy: ±0.03 Hz (50, 60 Hz), ±0.1 Hz (400 Hz range)
Integration mode	Range: 2 k counts/div to 1 M counts/div, 6 settings Accuracy: ±range/2000
Duty ratio mode	Range: Between 10 Hz to 100 kHz (minimum pulse width 2 μs), 5%/div (full scale = 20 div) Accuracy: ±1% (10 Hz to 10 kHz), ±4% (10 kHz to 100 kHz)
Pulse width mode	Range: Between 2 μs to 2 sec, 500 μs/div to 100 ms/div (full scale = 20 div), Accuracy: ±0.1% f.s.
Measurement resolution	1/2000 of range (Integration mode), 1/500 of range (exclude integration, power frequency mode), 1/100 of range (power frequency mode)
Input voltage range and threshold level	±10 V to ±400 V, 6 settings, selectable threshold level at each range
Other functions	Slope, Level, Hold, Smoothing, Low-pass filter, Switchable DC/AC input coupling, Frequency dividing, Integration over-range keep/return

Dimensions and mass: approx. 106 mm (4.17 in) W × 19.8 mm (0.78 in) H × 196.5 mm (7.74 in) D, approx. 250 g (8.8 oz)
Accessories: CONVERSION CABLE 9318 × 2 (To connect the current sensor to the 8971)



CURRENT UNIT 8971 (Accuracy at 23 ±5°C/73 ±9°F, 20 to 80% rh after 30 minutes of warm-up time and zero adjustment; Accuracy guaranteed for 1 year, Post-adjustment accuracy guaranteed for 1 year)	
Measurement functions	Number of channels: 2, Current measurement with optional current sensor,
Input terminals	Sensor connector (input impedance 1 MΩ, exclusive connector for current sensor via conversion cable the 9318, common GND with recorder)
Compatible current sensors	CT6863, CT6862, 9709, CT6841, CT6843, CT6844, CT6845, 9272-10 (To connect the 8971 via conversion cable the 9318)
Measurement range	Using 9272-10 (20 A), CT6841: 100 mA to 5 A/div (f.s. = 20 div, 6 settings) Using CT6862: 200 mA to 10 A/div (f.s. = 20 div, 6 settings) Using 9272-10 (200 A), CT6843, CT6863: 1 A to 50 A/div (f.s. = 20 div, 6 settings) Using CT6844, CT6845, 9709: 2 A to 100 A/div (f.s. = 20 div, 6 settings)
Measurement accuracy	±0.65% f.s. (with 5 Hz filter ON) RMS amplitude accuracy: ±1% f.s. (DC, 30 Hz to 1 kHz), ±3% f.s. (1 kHz to 10 kHz) RMS response time: 100 ms (rise time from 0 to 90% of full scale), Crest factor: 2 Frequency characteristics: DC to 100 kHz, ±3 dB (with AC coupling: 7 Hz to 100 kHz)
Measurement resolution	1/100 of range (using 12-bit A/D conversion)
Maximum sampling rate	1 MS/s (simultaneous sampling in 2 channels)
Other functions	Input coupling: AC/DC/GND, Low-pass filter: 5, 50, 500, 5 k, 50 kHz

Dimensions and mass: approx. 106 mm (4.17 in) W × 19.8 mm (0.78 in) H × 196.5 mm (7.74 in) D, approx. 250 g (8.8 oz)
Accessories: None



DC/RMS UNIT 8972 (Accuracy at 23 ±5°C/73 ±9°F, 20 to 80% rh after 30 minutes of warm-up time and zero adjustment; Accuracy guaranteed for 1 year, Post-adjustment accuracy guaranteed for 1 year)	
Measurement functions	Number of channels: 2, for voltage measurement, DC/RMS selectable
Input terminals	Isolated BNC connector (input impedance 1 MΩ, input capacitance 30 pF), Max. rated voltage to ground: 300 V AC or DC (with input isolated from the main unit, the maximum voltage that can be applied between input channel and chassis, and between input channels without damage)
Measurement range	5 mV to 20 V/div, 12 ranges, full scale: 20 div, AC voltage for possible measurement/display using the memory function: 280 V rms, Low-pass filter: 5/50/500 Hz, 5 k/100 kHz
Measurement resolution	1/100 of range (using 12-bit A/D conversion)
Maximum sampling rate	1 MS/s (simultaneous sampling in 2 channels)
Measurement accuracy	±0.5% of full scale (with filter 5 Hz, zero position accuracy included)
RMS measurement	RMS amplitude accuracy: ±1% f.s. (DC, 30 Hz to 1 kHz), ±3% of full scale (1 kHz to 100 kHz) Response time: SLOW 5 s (rise time from 0 to 90% of full scale), MID 800 ms (rise time from 0 to 90% of full scale), FAST 100 ms (rise time from 0 to 90% of full scale), Crest factor: 2
Frequency characteristics	DC to 400 kHz -3 dB, (with AC coupling: 7 Hz to 400 kHz -3 dB)
Input coupling	AC/DC/GND
Maximum input voltage	400 V DC (maximum voltage that can be applied between input connectors without damage)

Dimensions and mass: approx. 106 mm (4.17 in) W × 19.8 mm (0.78 in) H × 196.5 mm (7.74 in) D, approx. 190 g (6.7 oz)
Accessories: None



LOGIC UNIT 8973	
Measurement functions	Number of channels: 16 channels (4 ch/1 probe connector × 4 connectors)
Input terminals	Mini DIN connector (for HIOKI logic probes only), Compatible logic probes: 9320-01, 9327, MR9321-01

Dimensions and mass: approx. 106 mm (4.17 in) W × 19.8 mm (0.78 in) H × 196.5 mm (7.74 in) D, approx. 260 g (9.2 oz)
Accessories: None



DIGITAL VOLTMETER UNIT MR8990 <small>(Accuracy at 23 ±5°C/73 ±9°F, 20 to 80% rh after 30 minutes of warm-up time and calibration, Accuracy guaranteed for 1 year, Post-adjustment accuracy guaranteed for 1 year)</small>	
Measurement functions	Number of channels: 2, for DC voltage measurement
Input terminals	Banana input connectors (Input resistance: 100 MΩ or higher with 100 mV f.s. to 10 V f.s. range, otherwise 10 MΩ) Max. rated voltage to ground: 300 V AC or DC (with input isolated from the main unit, the maximum voltage that can be applied between input channel and chassis, and between input channels without damage)
Measurement range	100 mV f.s. (5 mV/div) to 1000 V f.s. (50 V/div), 5 ranges, full scale: 20 div
Measurement resolution	1/50 000 of measurement range (using 24 bit ΔΣ modulation A/D)
Integration time	20 ms ×NPLC (during 50 Hz), 16.67 ms ×NPLC (during 60 Hz)
Response time	2 ms +2× integration time or less (rise - f.s. → + f.s., fall + f.s. → - f.s.)
Basic measurement accuracy	±0.01% rdg. ±0.0025% f.s. (at range of 1000 mV f.s.)
Maximum input voltage	500 V DC (maximum voltage that can be applied between input connectors without damage)

Dimensions and mass: approx. 106 mm (4.17 in) W × 19.8 mm (0.78 in) H × 196.5 mm (7.74 in) D, approx. 230 g (8.1 oz)
Accessories: None



HIGH-VOLTAGE UNIT U8974 <small>(Accuracy at 23 ±5°C/73 ±9°F, 20 to 80% rh after 30 minutes of warm-up time and zero adjustment, Accuracy guaranteed for 1 year, Post-adjustment accuracy guaranteed for 1 year)</small>	
Measurement functions	Number of channels: 2, for voltage measurement, DC/RMS selectable Maximum rated voltage to ground: 1000 V AC or DC (CAT III), 600 V AC or DC (CAT IV)
Input terminals	Banana input terminal (Input impedance: 4 MΩ, Input capacitance: 5 pF)
Measurement range	200 mV, 500 mV, 1, 2, 5, 10, 20, 50 V/div (DC mode) 500 mV, 1, 2, 5, 10, 20, 50 V/div (RMS mode)
Measurement resolution	1/1600 of measurement range (using 16-bit A/D conversion)
Maximum sampling rate	1 MS/s
Measurement accuracy	±0.25% f.s. (with filter 5 Hz, zero position accuracy included)
RMS measurement	RMS accuracy: ±1.5% f.s. (DC, 30 Hz to 1 kHz), ±3% f.s. (1 kHz to 100 kHz) Response time: High speed 150 ms, Medium speed 500 ms, Low speed 2.5 s
Frequency characteristics	DC to 100 kHz -3 dB
Input coupling	DC / GND
Maximum input voltage	1000 V DC, 700 V AC

Dimensions and mass: approx. 106 mm (4.17 in) W × 19.8 mm (0.78 in) H × 196.5 mm (7.74 in) D, approx. 250 g (8.8 oz)
Accessories: None



ARBITRARY WAVEFORM GENERATOR UNIT U8793 <small>(Accuracy at 23 ±5°C/73 ±9°F, 80% rh or less after 30 minutes or more of warm-up time, Power supply frequency range of installed MEMORY RECORDER at 50 Hz/60 Hz ±2 Hz, Accuracy guaranteed for 1 year, Post-adjustment accuracy guaranteed for 1 year)</small>	
Output terminal	Number of channels: 2, SMB terminal (Output impedance: 1 Ω or less) Max. rated voltage to ground: 33 V rms AC or 70 V DC
Output voltage range	-10 V to 15 V (Amplitude setting range: 0 V to 20 V p-p, Setting resolution: 1 mV)
Max. output current	10 mA (Allowable load resistance: 1.5 kΩ or more)
FG function	DC, Sine wave, Square wave, Pulse wave, Triangular wave, Ramp wave, Output frequency: 0 Hz to 100 kHz
Arbitrary waveform generator mode	Waveforms measured by MR8847A, etc., generated by Hioki Model 7075 or SF8000, CSV waveforms D/A refresh rate: 2 MHz (using 16-bit D/A)
Sweep function	Frequency, Amplitude, Offset, Duty (Pulse only)
Program function	Max. 128 steps (Number of loops for each step, Number of total loops)
Other	Self-test function (Voltage), External input/output control

Dimensions and mass: approx. 106 mm (4.17 in) W × 19.8 mm (0.78 in) H × 196.5 mm (7.74 in) D, approx. 230 g (8.1 oz)
Accessories: None



WAVEFORM GENERATOR UNIT MR8790 <small>(Accuracy at 23 ±5°C/73 ±9°F, 80% rh after 30 minutes of warm-up time, Accuracy guaranteed for 1 year, Post-adjustment accuracy guaranteed for 1 year)</small>	
Output terminal	Number of channels: 4, SMB terminal (Output impedance: 1 Ω or less) Max. rated voltage to ground: 33 V rms AC or 70 V DC
Output voltage range	-10 V to 10 V (Amplitude setting range: 0 V to 20 V p-p, Setting resolution: 1 mV)
Max. output current	5 mA
Output function	DC, Sine wave (Output frequency range: 0 Hz to 20 kHz)
Accuracy	Amplitude accuracy: ±0.25% of setting ±2 mV p-p (1 Hz to 10 kHz) Offset accuracy: ±3 mV DC output accuracy: ±0.6 mV
Other	Self-test function (Voltage, Current)

Dimensions and mass: approx. 106 mm (4.17 in) W × 19.8 mm (0.78 in) H × 196.5 mm (7.74 in) D, approx. 230 g (8.1 oz)
Accessories: None



PULSE GENERATOR UNIT MR8791 <small>(Accuracy at 23 ±5°C/73 ±9°F, 80% rh or less with no condensation, Accuracy guaranteed for 1 year)</small>	
Output terminal	Number of channels: 8, Connector: D-sub, half-pitch, 50-pin Max. rated voltage to ground: 33 V rms AC or 70 V DC (between unit and output channels) Logic output/Open collector output
Output mode 1	Pattern output: Read frequency: 0 Hz to 120 kHz, 2048 logic patterns Pulse output: Frequency 0 Hz to 20 kHz, Duty 0.1% to 99.9%
Output mode 2	Logic output: Output voltage level: 0 V to 5 V (H level: 3.8 V or more, L level: 0.8 V or less) Open collector output: Absolute maximum rated voltage for collector/emitter: 50 V Overcurrent protection: 100 mA
Other	Self-test function

Cable length and mass: Input side: 70 cm (2.30 ft), Output side: 1.5 m (4.92 ft), Approx. 170 g (6.0 oz)



DIFFERENTIAL PROBE P9000 <small>(Accuracy guaranteed for 1 year, Post-adjustment accuracy guaranteed for 1 year)</small>	
Measurement modes	P9000-01: For waveform monitor output, Frequency characteristics: DC to 100 kHz -3 dB P9000-02: Switches between waveform monitor output/AC effective value output Wave mode frequency characteristics: DC to 100 kHz -3 dB, RMS mode frequency characteristics: 30 Hz to 10 kHz, Response time: Rise 300 ms, Fall 600 ms
Division ratio	Switches between 1000:1, 100:1
DC output accuracy	±0.5% f.s. (f.s. = 1.0 V, division ratio 1000:1), (f.s. = 3.5 V, division ratio 100:1)
Effective value measurement accuracy	±1% f.s. (30 Hz to less than 1 kHz, sine wave), ±3% f.s. (1 kHz to 10 kHz, sine wave)
Input resistance/capacity	H-L: 10.5 MΩ, 5 pF or less (At 100 kHz)
Maximum input voltage	1000 V AC, DC
Maximum rated voltage to ground	1000 V AC, DC (CAT III)
Operating temperature range	-40°C to 80°C (-40°F to 176°F)
Power supply	(1) AC adapter Z1008 (100 to 240 V AC, 50/60 Hz), 6 VA (including AC adapter), 0.9 VA (main unit only) (2) USB bus power (5 V DC, USB micro-B connector), 0.8 VA (3) External power source 2.7 V to 15 V DC, 1 VA
Accessories	Instruction manual ×1, Alligator clip ×2, Carrying case ×1

Cable length and mass: Main unit cable 1.3 m (4.27 ft), input section cable 46 cm (1.51 ft), approx. 350 g (12.3 oz)



DIFFERENTIAL PROBE 9322 <small>(Accuracy guaranteed for 1 year)</small>	
Functions	For high-voltage floating measurement, power line surge noise detection, RMS rectified output measurement
DC mode	For waveform monitor output, Frequency characteristics: DC to 10 MHz (±3 dB), Amplitude accuracy: ±1% of full scale (at max. 1000 V DC), ±3% of full scale (at max. 2000 V DC) (full scale: 2000 V DC)
AC mode	For detection of power line surge noise, Frequency characteristics: 1 kHz to 10 MHz ±3 dB
RMS mode	DC/AC voltage RMS output detection, Frequency characteristics: DC, 40 Hz to 100 kHz, Response speed: 200 ms or less (400 V AC), Accuracy: ±1% of full scale (DC, 40 Hz to 1 kHz), ±4% of full scale (1 kHz to 100 kHz) (full scale: 1000 V AC)
Input	Input type: balanced differential input, Input impedance/capacitance: H-L 9 MΩ/10 pF, H/L-unit 4.5 MΩ/20 pF, Max. rated voltage to ground: when using grabber clip 1500 V AC/DC (CAT II), 600 V AC/DC (CAT III), when using alligator clip: 1000 V AC/DC (CAT II), 600 V AC/DC (CAT III)
Maximum input voltage	2000 V DC, 1000 V AC (CAT II), 600 V AC/DC (CAT III)
Output	Voltage divider for 1/1000 of input, BNC connectors (output switchable for 3 modes DC, AC, RMS)
Power supply	Any of the following: (1) AC Adapter 9418-15, (2) Power Cord 9248 with Probe Power Unit 9687, (3) Power Cord 9324 + Conversion Cable 9323 with HiCORDER logic terminal, (4) Power Cord 9325 with F/V Unit 8940

Cable length and mass: Main unit cable 1.5 m (4.92 ft), input section cable 30 cm (0.98 ft), approx. 150 g (5.3 oz)

Note: The unit-side plug of the 9320-01 and 9327 is different from the 9320.



LOGIC PROBE 9320-01/9327	
Functions	Detection of voltage signal or relay contact signal for High/Low state recording
Input	4 channels (common ground between unit and channels), digital/contact input, switchable (contact input can detect open-collector signals) Input resistance: 1 MΩ (with digital input, 0 to +5 V) 500 kΩ or more (with digital input, +5 to +50 V) Pull-up resistance: 2 kΩ (contact input: internally pulled up to +5 V)
Digital input threshold	1.4 V / 2.5 V / 4.0 V
Contact input detection resistance	1.4 V: 1.5 kΩ or higher (open) and 500 Ω or lower (short) 2.5 V: 3.5 kΩ or higher (open) and 1.5 kΩ or lower (short) 4.0 V: 25 kΩ or higher (open) and 8 kΩ or lower (short)
Response speed	9320-01: 500 ns or lower, 9327: detectable pulse width 100 ns or higher
Maximum input voltage	0 to +50 V DC (the maximum voltage that can be applied across input pins without damage)

Cable length and mass: Main unit cable 1.5 m (4.92 ft), input section cable 1 m (3.28 ft), approx. 320 g (11.3 oz)

Note: The unit-side plug of the MR9321-01 is different from the MR9321.



LOGIC PROBE MR9321-01	
Functions	Detection of AC or DC relay drive signal for High/Low state recording Can also be used for power line interruption detection
Input	4 channels (isolated between unit and channels), HIGH/LOW range switching Input resistance: 100 kΩ or higher (HIGH range), 30 kΩ or higher (LOW range)
Output (H) detection	170 to 250 V AC, ±DC 70 to 250 V (HIGH range) 60 to 150 V AC, ±DC 20 to 150 V (LOW range)
Output (L) detection	0 to 30 V AC, ±DC 0 to 43 V (HIGH range) 0 to 10 V AC, ±DC 0 to 15 V (LOW range)
Response time	Rising edge 1 ms max., falling edge 3 ms max. (with HIGH range at 200 V DC, LOW range at 100 V DC)
Maximum input voltage	250 V rms (HIGH range), 150 V rms (LOW range) (the maximum voltage that can be applied across input pins without damage)

More Functional Details

Frequency area data analysis (FFT function)

Electrical distortion analysis/mechanical vibration analysis

FFT analysis function

This function comprises single-signal FFT for tasks such as frequency component analysis, dual-signal FFT for transfer function analysis, and octave analysis for acoustic measurements. The signal source for analysis are selectable from 1,000 to 10,000 data points.

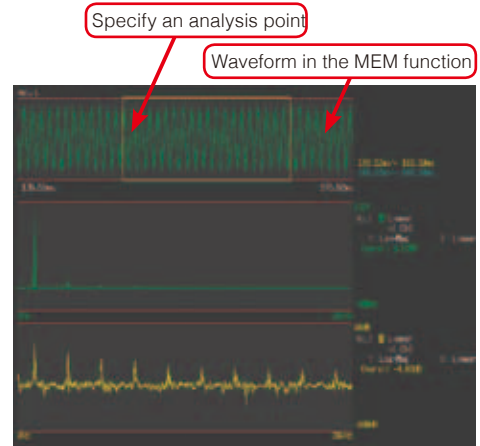

HTTP/FTP server function

A 100BASE-TX LAN port is built in as standard equipment. <HTTP server capability>

Access the unit via a web browser running on a computer, for waveform observation and remote operation. Waveform data of the MR8740/MR8741 series can also be downloaded and pasted onto Excel.

<FTP server capability>

Copy the memory contents of the MR8740/MR8741 (USB memory, internal RAM) to a computer.

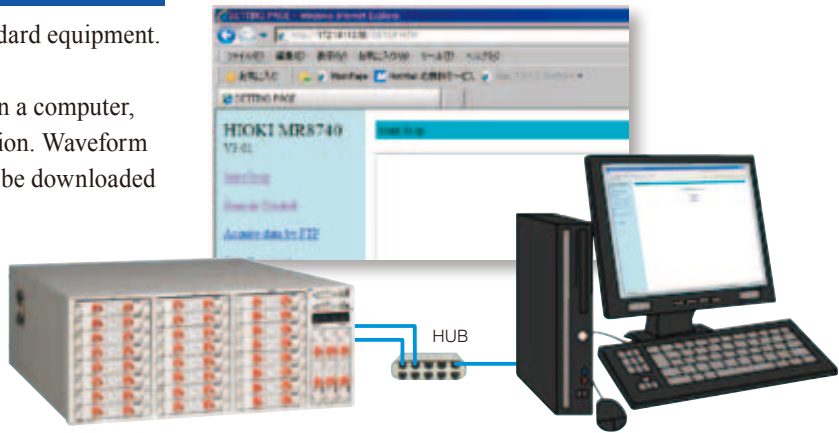

Analyzing data on a computer

● WAVE PROCESSOR 9335 (option)

- Waveform display and calculation
- Print function

● LAN COMMUNICATOR 9333 (option)

- Collect waveform data
- Remotely control Memory HiCorders with a PC
- Save data in CSV format and export to spreadsheet applications

● iPad App for Memory HiCorder HMR Terminal (option)

- Free app (exclusively for iPad) downloadable from the App Store
- Freely control waveforms using iPad's gesture controls
- Multi-channel support – up to 32 channels (with MR8827, MR8740) of waveform data at your fingertips
- Operate the Memory HiCorder via network. You can change settings, and monitor waveforms during measurement.

*New function on Ver 2.0

Data can be viewed by the iPad using Hioki's dedicated apps available from the App Store. Search for "HIOKI" and download the "HMR Terminal" app.

*iOS is a registered trademark of Cisco Technology, Inc. and/or its affiliates in the United States and certain other countries.
*iPhone, iPad, iPad mini, iPad Pro and iPod touch are trademarks of Apple Inc.
*Apple and the Apple logo are trademarks of Apple Inc. App Store is a service mark of Apple Inc.

● Wave Viewer (Wv) Software (bundled software)

- Confirmation of binary data waveforms on a computer
- Saving data in the CSV format for transfer to spreadsheet software

■ Wave Viewer (Wv) Outline specifications (bundled software)

Operating environment	Windows 10/8/7 (32/64-bit), Vista (32-bit), XP
Functions	<ul style="list-style-type: none"> • Simple display of waveform file • Convert binary data file to text format, CSV • Scroll display, enlarge/reduce, jump to cursor/trigger position, etc.

■ 9335 Outline specifications (option)

Operating environment	Computer running under Windows 10/8/7 (32/64-bit), Vista (32-bit), XP
Functions	<ul style="list-style-type: none"> • Display: Waveform display, X-Y display, cursor function, etc. • File loading: Readable data formats (MEM, .REC, .RMS, .POW) Largest readable file: Largest file that can be saved by supported instruments (Supported file size may be limited due to computer's operating environment.) • Data conversion: Conversion to CSV format, batch conversion of multiple files
Print	<ul style="list-style-type: none"> • Print function: Saving of print image files (with support for enhanced metafile [EMF] format) • Print format: Select from no tiling, 2 to 16 tiles, 2 to 16 rows, X/Y 1 to 4 tiles, preview/hard copy

■ 9333 Outline specifications (option)

Supported units	MR8740 (ver 3.12 or later), MR8741 (ver 2.12 or later) and similar products
Operating environment	Computer running under Windows 10/8/7 (32/64-bit), Vista (32-bit), XP <i>Note: 9333 Ver.1.09 or later</i>
Functions	<ul style="list-style-type: none"> • Auto-saves waveform data to PC, Remote control of Memory HiCorder (by sending key codes and receiving images on screen), print reports, print images from the screen, receive waveform data in same format as waveform files from the Memory HiCorder (binary only) • Waveform data acquisition: Accept auto-saves from the Memory HiCorder, same format as auto-save files of Memory HiCorder (binary only), print automatically with a Memory HiCorder from a PC. The Memory HiCorder's print key launches printouts on the PC • Waveform viewer: Simple display of waveform files, conversion to CSV format, or other

■ HMR Terminal Outline specifications (free software)

Supported units	MR8740, MR8741 and similar products * calculated waveforms and logical waveforms not supported
Operating environment	iOS on the iPad (Apple Inc.)
Functions	<ul style="list-style-type: none"> • Data acquisition: Send to iPad via FTP using a WiFi router, or load to iPad via iTunes (PC app) • Intuitively operate waveform level searches, maximum / minimum / average values, zero position adjustment, and more at your fingertips • Waveform monitoring • Meter setting <p>* Logic waveforms and computational waveforms are not supported.</p>

Specifications

Basic specifications (Accuracy guaranteed for 1 year, Post-adjustment accuracy guaranteed for 1 year)	
Measurement functions	MEMORY (high-speed recording, X-Y), RECORDER (real-time recording), FFT (frequency analysis) (Recorder functionality scheduled to be available by the end of 2012.)
Number of input units	MR8740 : 27units + 16 logic channels (standard) MR8741: 8units + 16 logic channels (standard) * For analog units, channels are isolated from each other and from frame GND. For logic units and internal standard logic terminals, all channels have common GND.
Maximum sampling rate	20 MS/second (50 ns period, all channels simultaneously) External sampling (10 MS/second, 100 ns period)
Internal memory	MR8740: Block I; Total 512 M-words (16MW/ch) Block II; Total 352 M-words (16MW/ch) MR8741: Total 256 M-words (16MW/ch)
Data storage media	USB memory stick (USB 2.0)
Backup functions (At 25°C/ 77°F)	Clock and parameter setting backup: at least 10 years Waveform backup function: none
External control connectors (MR8741only)	Terminal block: External trigger input, Trigger output, External sampling input, Two external outputs (GO/NG output), Three external inputs (start, stop, save)
External interfaces	LAN: 100BASE-TX (DHCP, DNS supported, FTP server, HTTP server) USB: USB2.0 compliant, series A receptacle ×2
Environmental conditions (No condensation)	Operation: 0°C (32°F) to 40°C (104°F), 20 % to 80 % rh Storage: -10°C (14°F) to 50°C (122°F), 90 % rh or less
Compliance standard	Safety: EN61010
Power supply	100 to 240 V AC, 50/60 Hz
Power consumption	MR8740: 250 VA, MR8741: 120 VA
Dimensions and mass (main unit only)	MR8740: Approx. 426 mm (16.77 in) W × 177 mm (6.97 in) H × 505 mm (19.88 in) D, 10.8 kg (381.0 oz) MR8741: Approx. 350 mm (13.78 in) W × 160 mm (6.30 in) H × 320 mm (12.60 in) D, 5.4 kg (190.5 oz)
Supplied accessories	Instruction Manual × 1, Application Disk (Wave Viewer Wv, Communication Commands table) × 1, Power cord × 1, rack-mounting hardware (EIA standard) × 1set (MR8740 only)
MEMORY (high-speed recording)	
Time axis	5 μs to 5 min/div (100 samples/div) 26 ranges, External sampling (MR8740 only), Time axis zoom: ×2 to ×10 in 3 stages, compression: 1/2 to 1/20,000 in 13 stages
Sampling period	1/100 of time axis range (minimum 50 ns period)
Recording length	25 to 100,000 div, or arbitrary setting in 1-div steps (max. 160,000 div)
Pre-trigger	Record data from before the trigger point at 0 to +100% or -95% of the recording length in 15 stages, or in 1 div step settings
Numerical calculation	<ul style="list-style-type: none"> Simultaneous calculation for up to 16 selected channels Average value, effective (rms) value, peak to peak value, maximum value, time to maximum value, minimum value, time to minimum value, period, frequency, rise time, fall time, standard deviation, area value, X-Y area value, specified level time, specified time level, pulse width, duty ratio, pulse count, four arithmetic operations, Time difference, phase difference, high-level and low-level Calculation result evaluation output: GO/NG Automatic storing of calculation results
Waveform processing	For up to 16 freely selectable channels, the following functions can be performed (results are automatically stored): Four arithmetic operations, absolute value, exponentiation, common logarithm, square root, moving average, differentiation (primary, secondary), integration (primary, secondary), parallel displacement along time axis, trigonometric functions, reverse trigonometric functions
Memory segmentation	Max. 1024 blocks
Other functions	<ul style="list-style-type: none"> No logging X-Y waveform synthesis (1-screen, 4-screens) Overlay (always overlay when started/overlay only required waveforms)
RECORDER (real-time recording)	
Time axis	10 ms to 1 hour/div, 19 ranges, time axis resolution 100 points/div Note: Out of data acquired at selected sampling rate, only maximum and minimum value data determined using 100 points/div units are stored. Time axis compression selectable in 13 steps, from × 1/2 to × 1/20,000
Sampling rate	1/10/100 μs 1/10/100 ms (selectable from 1/100 or less of time axis)
Recording length	Built-in presets of 25 - 50,000 div, or "Continuous" or arbitrary setting in 1-div steps (max. 80,000 div)
Waveform memory	Store data for most recent 80,000 div in memory
Auto save	Data is automatically saved in USB memory stick after measurement stops

Trigger functions	
Trigger mode	MEMORY (high-speed recording), FFT: Single, Repeat, Auto RECORDER* (real-time recording): Single, Repeat
Trigger sources	CH1 to CH16 (analog), Standard Logic 16ch + Logic Unit (Max. 3 units 48 channels), External, Timer, Manual (either ON or OFF for each source), Logical AND/OR of sources
Trigger types	<ul style="list-style-type: none"> Level: Triggering occurs when preset voltage level is crossed (upwards or downwards) Voltage drop: Triggering occurs when voltage drops below peak voltage setting (for 50/60 Hz AC power lines only) Window: Triggering occurs when window defined by upper and lower limit is entered or exited Period: Rising edge or falling edge cycle of preset voltage value is monitored and triggering occurs when defined cycle range is exceeded Glitch: Triggering occurs when pulse width from rising or falling edge of preset voltage value is under run Event setting: Event count is performed for each source, and triggering occurs when a preset count is exceeded Logic: 1, 0, or ×, Pattern setting
Level setting resolution	0.1% of full scale (full scale = 20 divisions)
Trigger filter	Selectable 0.1div to 10.0div, or OFF (at MEMORY function) ON (10ms fixed) or OFF (at RECORDER function*)
Trigger output (MR8741 only)	Open collector (5 voltage output, active Low) At Level setting: pulse width (Sampling period × data number after trigger) At Pulse setting: pulse width (2ms)
Other functions	Trigger priority (OFF/ON), Pre-trigger function for capturing data from before / after trigger event (at MEMORY function), Level display during trigger standby, Start and stop trigger (At RECORDER function*), Trigger search function

FFT	
Analysis mode	Storage waveform, Linear spectrum, RMS spectrum, Power spectrum, Density of power spectrum, Cross power spectrum, Auto-correlation function, Histogram, Transfer function, Crosscorrelation function, Impulse response, Coherence function, 1/1 Octave analysis, 1/3 Octave analysis, LPC analysis, Phase spectrum
Analysis channels	Selectable from all analog input channels
Frequency range	133 mHz to 8 MHz, External, (resolution 1/400, 1/800, 1/2000, 1/4000)
Number of sampling points	1000, 2000, 5000, 10000 points
Window functions	Rectangular, Hanning, Hamming, Blackman, Blackman-Harris, Flattop, Exponential
Display format	Single, Dual, Nyquist, Running spectrum
Averaging function	Time axis / frequency axis simple averaging, Exponential averaging, Peak hold (frequency axis), Averaging times: 2 times to 10,000 times

Other functions	
Waveform judgment function (In MEMORY or FFT function) (MR8741 only)	<ul style="list-style-type: none"> Area comparison with reference waveform area for time domain waveform, X-Y waveform, or FFT analysis waveform Parameter calculated value comparison with reference value Output: GO/NG decision, Open-collector 5V, <i>Note: Judge waveforms in near real-time at samplings speeds of 100msec/div (1ms sampling) or slower.</i>

Maximum Recording Time for the internal memory (At MEMORY Function)

Time axis	5 μs/div	10 μs/div	20 μs/div	50 μs/div	100 μs/div	200 μs/div	500 μs/div	1 ms/div	2 ms/div	5 ms/div	10 ms/div	20 ms/div	50 ms/div
Sampling period	50 ns	100 ns	200 ns	500 ns	1 μs	2 μs	5 μs	10 μs	20 μs	50 μs	100 μs	200 μs	500 μs
Recording Time	0.8 s	1.6 s	3.2 s	8 s	16 s	32 s	1 min 20 s	2 min 40 s	5 min 20 s	13 min 20 s	26 min 40 s	53 min 20 s	2 h 13 min 20 s
Time axis	100 ms/div	200ms/div	500ms/div	1s/div	2s/div	5s/div	10s/div	30s/div	50s/div	1min/div	100s/div	2min/div	5min/div
Sampling period	1 ms	2ms	5ms	10ms	20ms	50ms	100ms	300ms	500ms	600ms	1.0s	1.2s	3.0s
Recording Time	4 h 26 min 40 s	8 h 53 min 20 s	22 h 13 min 20 s	1 d 20 h 26 min 40 s	3 d 16 h 53 min 20 s	9 d 06 h 13 min 20 s	18 d 12 h 06 min 40 s	55 d 13 h 20 min 00 s	92 d 14 h 13 min 20 s	111 d 02 h 40 min 00 s	185 d 04 h 26 min 40 s	222 d 05 h 20 min 00 s	555 d 13 h 20 min 00 s

