

An Evolution in Stable Measurements

Perfect for Taping Machines and Sorting Machines

NEW RM3542A

Supports Resistance Measurements for
Miniature 008004-size Electronic Parts (0.25 mm × 0.125 mm)



New
concept

RM3542A The Evolution is Here

Improved Productivity and Low-impact Measuring

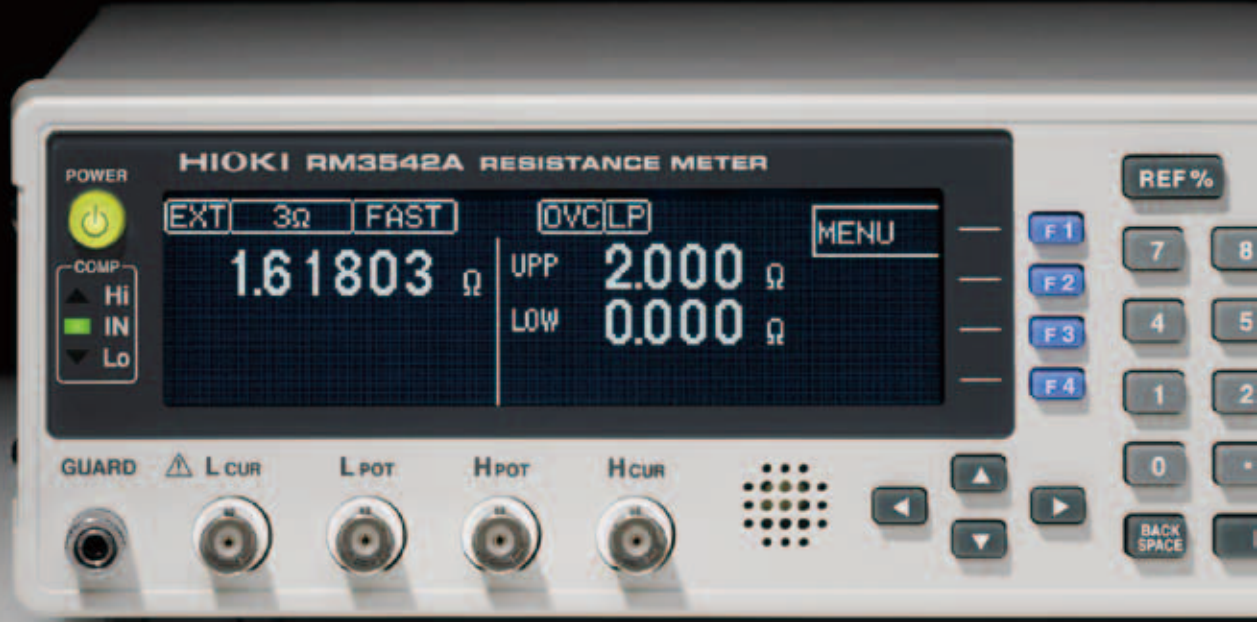

Minimized Variations and Enhanced Measurement Range

RM3542A

An fuller lineup of measurement ranges means that more appropriate ranges and higher resolution testing are now available for your application. The new measurement currents that complement the added ranges ensure detection voltage, improve the S/N ratio and suppress variation.

Achieve Stable Measurements in a Wide Measurement Range
 Range added with RM3542A

150 Ω
Measurement
Comparison

Example of Reduced Variation with the New Range

Comparison data with the same sample

Range	Measurement Current
100 mΩ	100 mA
1000 mΩ	100 mA
3 Ω	33.3 mA
10 Ω	10 mA
100 Ω	10 mA
300 Ω	3.33 mA
1000 Ω	1 mA
10 kΩ	1 mA
30 kΩ	333 μA
100 kΩ	100 μA
300 kΩ	33.3 μA
1000 kΩ	10 μA
3 MΩ	3.33 μA
10 MΩ	1 μA
30 MΩ	333 nA
100 MΩ	100 nA

New concept

300 Ω Range

1000 Ω Range

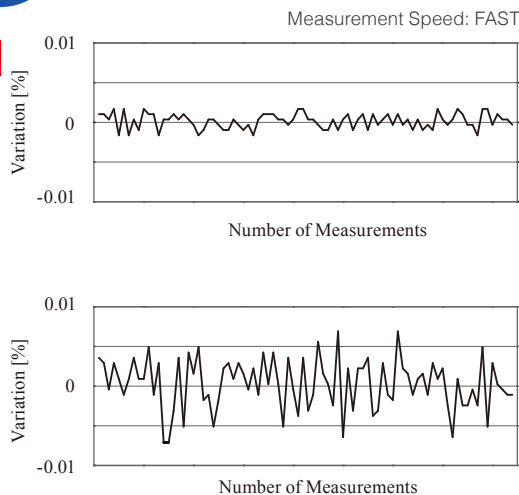

Scaling Function Used to Compensate for Mounted State

New concept

RM3542A

Use the Scaling Function to compensate for the differences in resistance when inspecting individual parts and parts mounted on a board. This function is very useful for inspecting the current detection resistance of low resistors, such as shunts.

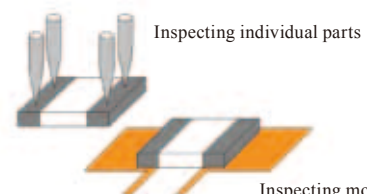

Reduce Contact Error Rate and Increase Production Volume

RM3542A

The RM3542A represents an evolution in the Contact Improver Function*1 for low-power measurements. Contact errors are reduced by improved contact between probes and samples.

*1 The Contact Improver Function is described on Page 4.

New concept Low-impact Contact Improvement by Suppressing Rush Current

By suppressing the surge of rush current into samples, there is now a broader range of scenarios in which contact improvement can be used, such as the inspection of small ferrite beads and small 008004-sized(0.25 mm × 0.125 mm) resistors.

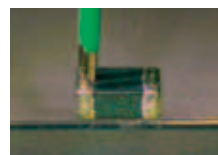
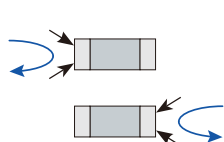

Image of Contact

Contact Improvement by Suppressing Characteristic Changes in Ferrite Beads

RM3542A : Alternating Contact Improvement on the H Side and L Side



Rush current into samples is reduced.

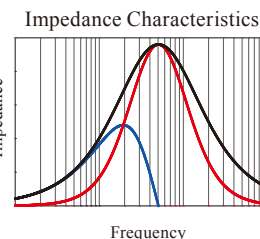
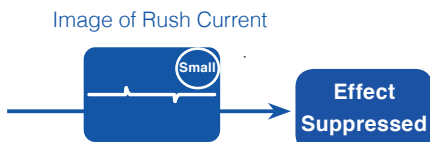

RM3542 : Simultaneous Contact Improvement on the H Side and L Side

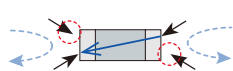

If the probe has poor contact, rush current flows into the sample.

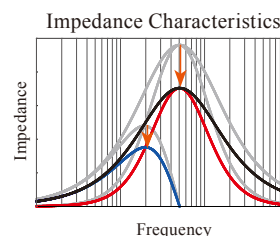
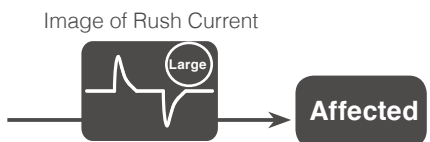

[Low-impact Contact Improvement Conditions] LOW POWER: ON or Applied Voltage Limit Function: ON, and Contact Improver Function set to Pulse.

Low-impact Measurement of Miniature 008004-sized Parts (0.25 mm × 0.125 mm)

RM3542A

By limiting applied voltage to 5 V or less when measuring, it is possible to measure 008004 size (0.25 mm × 0.125 mm) parts that have a low rated voltage without applying stress.

Applied Voltage Limit Function: OFF

Object under test	Measurement Current	Applied Voltage
:	:	:
1 kΩ	1 mA	1 V
2 kΩ		2 V
3 kΩ		3 V
4 kΩ		4 V
5 kΩ		5 V
6 kΩ		6 V
7 kΩ		7 V
8 kΩ		8 V
9 kΩ		9 V
10 kΩ		10 V
:	:	:

No Limit

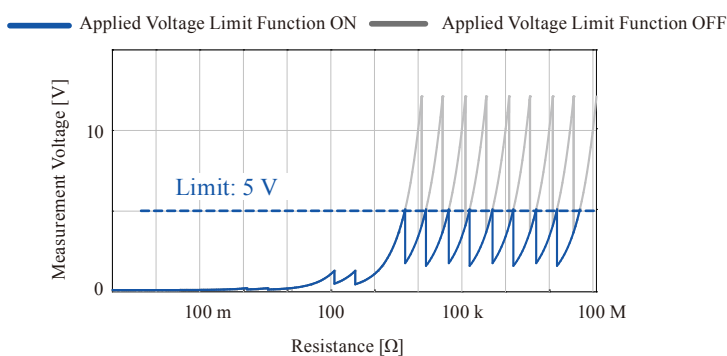

Applied Voltage Limit Function: ON

Object under test	Measurement Current	Applied Voltage
:	:	:
1 kΩ	1 mA	1 V
2 kΩ		2 V
3 kΩ		3 V
4 kΩ		4 V
5 kΩ		5 V
6 kΩ		2 V
7 kΩ		2.3 V
8 kΩ		2.6 V
9 kΩ		3 V
10 kΩ		3.3 V
:	:	:

New concept Voltage Limit

Measurement Current	Range of Application	
	Applied Voltage Limit OFF	Applied Voltage Limit ON
1 mA	10 kΩ	5 kΩ
333 μA	30 kΩ	15 kΩ
100 μA	100 kΩ	50 kΩ
33.3 μA	300 kΩ	150 kΩ
10 μA	1000 kΩ	500 kΩ
3.33 μA	3 MΩ	1500 kΩ
1 μA	10 MΩ	5 MΩ
333 nA	30 MΩ	15 MΩ
100 nA	100 MΩ	50 MΩ

Consistent Reliability

Perfect for Automation

Reliability Improved with Positive Contact Contact Checking while Measuring

Reliable checking and reduced contact time are achieved by performing contact checks while measuring, instead of before and after, as is traditionally done.

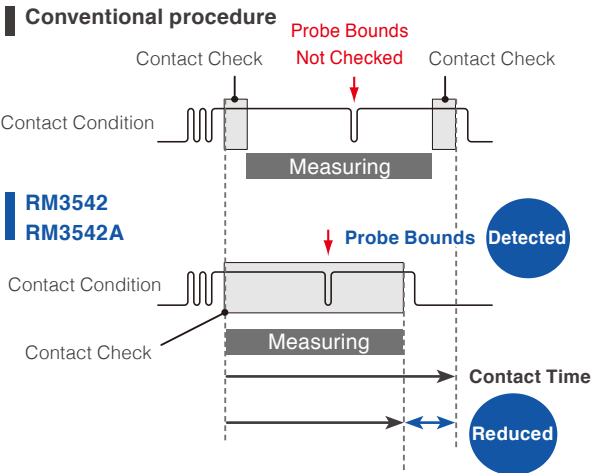

Monitor Contact Condition Detect Contact Errors (Voltage Monitor Function)

Large voltage fluctuations due to changes in current terminal contact resistance or noise from mechanical vibrations are detected as errors.

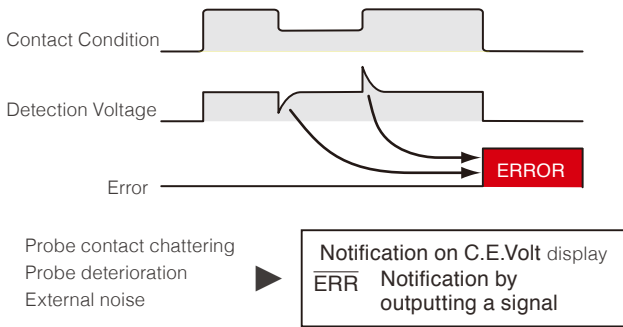

Reduce Contact Error Rate Repeat Measurement when an Error Occurs (Retry Function)

The Retry Function automatically repeats the measurement when a fault occurs due to probe chatter.

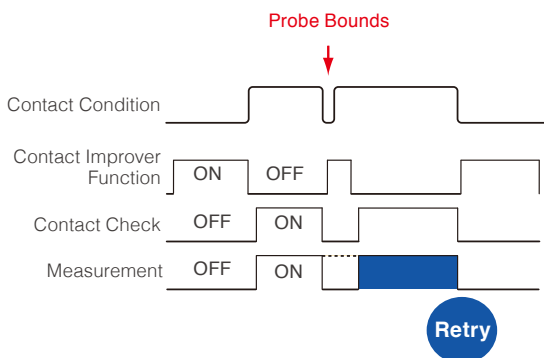

RM3542A

RM3542

Shared Features

Productivity Improved

Reduce Contact Error Rate Contact Improver Function Ensures Quick and Reliable Contact

Contact is improved by penetrating oxidation and impurities between probes and samples. Measurements stabilized by improving poor contact, and a reduction in the contact error rate, lead to improvements in productivity.

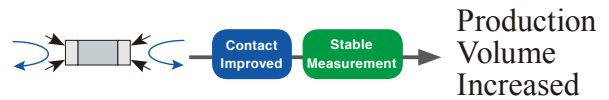

Choices for contact improvement current: 17 mA, 25 mA, 35 mA (default value), 50 mA

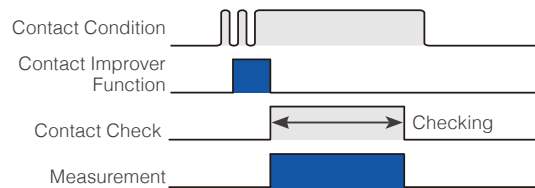

Noise Resistant

Reduce Measurement Time for More Stable Measurements Integration Time Setting Function

You can set the integration time as desired for each range. Set a short integration time to reduce the takt time, or a long integration time for more stable inspection.

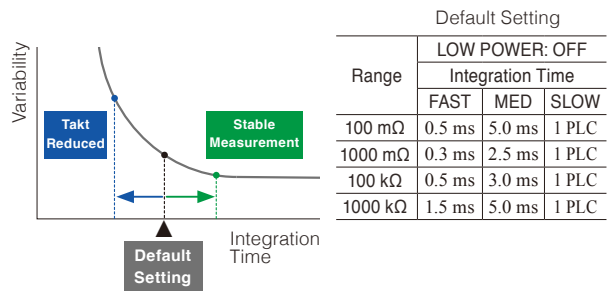

Noise-Resistant Floating Structure

The floating structure of the measurement area minimizes any effects from nearby noise on the measurement values.

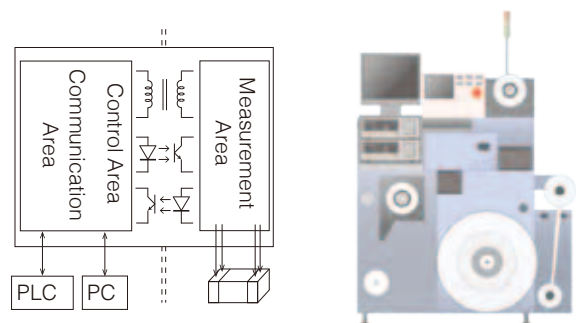

Recording, Statistics, Output

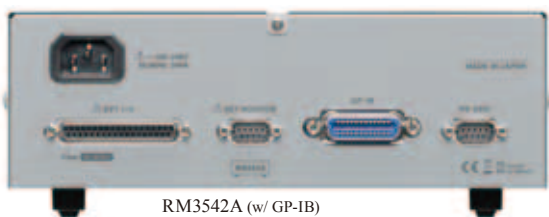

RM3542A (w/ GP-IB)

Data Storage Function

Saving to Internal Memory via Trigger Signal or Key Operation

All trigger measurement values during external trigger measurement, or trigger input for measurements during internal trigger settings, are saved to internal memory (30000 Max.).

Auto-Memory Function

Auto [Saving] and [Printing] when Measurement Values are Stable

During internal trigger settings, measurement values can be automatically saved to memory when a probe contacts resistance. When the set number (max. 99) is saved to memory the function stops, statistical calculations are performed, and the data is output to the screen or a printer (RS-232C).

Printing Example (NORMAL) Printing Example (SAMPLE)

7	219.701 Ohm IN	-0.136%/IN	+0.014%/IN	+0.312%/IN
8	220.031 Ohm IN	-31.764%/Lo	+50.030%/Hi	+999.999%/Hi
9	220.687 Ohm IN	MEAS.ERR/--	MEAS.ERR/--	
10	150.119 Ohm Lo			
11	330.065 Ohm Hi			
12	OvrRng	Hi		
13	C.E.Lo	--		
14	C.E.Hi	--		

3 sets of data are printed on 1 line to save paper.

External Output

RM3542A Pin Layout

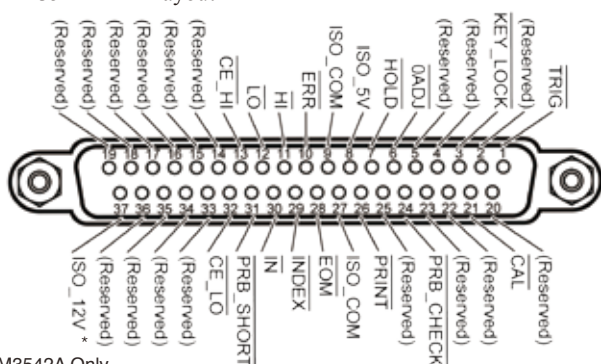

*RM3542A Only

Connector

Connector used : 37-pin D-sub female connector with #4-40 inch screws (on the main unit)
 : DC-37P-ULR (solder type), DCSP-JB37PR (crimped type)
 Compatible connectors : Japan Aviation Electronics Industry, Ltd.

Electrical Specifications

Input Signals	Input type	Photocoupler isolation: Non-voltage contact inputs (Current sync output supported) (negative logic)
	Input ON voltage	1 V or less
	Input OFF voltage	OPEN or 5 V to 30 V
	Input ON current	3 mA/ch
	Max. applied voltage	30 V
Output Signals	Output type	Photocoupler isolation: Open-collector npn output (Current sync) (negative logic)
	Max. load voltage	30 V
	Max. output current	50 mA/ch
	Residual voltage	1 V (10 mA), 1.5 V (50 mA)
Built-in Insulation Power	+5 V power output	
	Output voltage	4.5 V to 5.0 V
	Max. output current	100 mA
	+12 V power output	
	Output voltage	11.0 V to 13.0 V
	Max. output current	20 mA
	External power input	None

Example of Typical EXT. I/O Timing

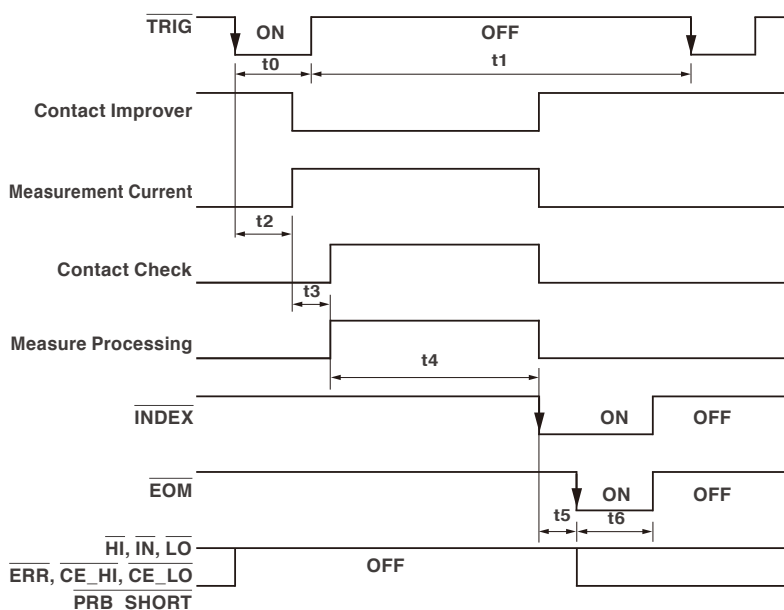

t0	Trigger Pulse ON	0.1 ms or greater	Rising/Falling edge selection possible
t1	Trigger Pulse OFF	0.1 ms or greater	
t2	Delay 1	0 to 100 ms	According to settings
t3	Delay 2	0 to 100 ms	According to settings (0.1 ms or 0.3 ms added when the Contact Improver Function is set to Pulse)
t4	Measurement Time	0.1 ms to 100 ms	According to sampling speed, OVC settings, measurement range and power supply frequency
t5	Calculation Time	0.1 ms	Delayed when statistical calculation and the memory function are ON.
t6	EOM Pulse Width	1 to 100 ms	According to settings

EXT.I/O Signal List

● Input Signals	
TRIG	External Trigger
OADJ	Zero-Adjust
PRINT	Printing
CAL	Self-Calibration
HOLD	Hold
PRB_CHECK	Probe Short-Circuit Detection
KEY_LOCK	Key Lock
● Output Signals	
ERR	Measurement Fault Output
CE_HI	Contact error (H _{CUR} , H _{POT} side)
CE_LO	Contact error (L _{CUR} , L _{POT} side)
PRB_SHORT	Probe short-circuit error
INDEX	End of Import
EOM	End of Measurement
HI, IN, LO	Comparator judgment
ISO_5V	Isolated power +5 V output
ISO_12V	Isolated power +12 V output
ISO_COM	Isolated power common

Requirement Specification (Printer)

Interface	RS-232C	RM3542 Main unit connector	1 2 3 4 5		
Characters per line	At least 45		6 7 8 9		
Communication speed	9600 bps		Function	Signal Name	Pin
Data bits	8 bit		Receive Data	R x D	2
Parity	None	Transmit Data	T x D	3	
Stop bits	1 bit	Signal Ground	GND	5	
Flow control	None				

General Specifications

Operating environment	Indoors, pollution degree 2, altitude up to 2000 m (6562 ft)
Operating temperature and humidity	0°C to 40°C (32°F to 104°F), 80% RH or less(no condensation)
Storage temperature and humidity	-10°C to 50°C (14°F to 122°F), 80% RH or less(no condensation)
Power supply/Maximum rated power consumption	100 V to 240 V AC (50 Hz/60 Hz)/30 VA
Dielectric strength	1.62 kV AC, 1 minute Between all mains supply terminals and protective ground, interfaces, and measurement jacks
Compliance standard	EMC: EN61326, EN61000 Safety: EN61010
Dimensions/mass	Approx. 260 mm (10.24 in) W × 88 mm (3.46 in) H × 300 mm (11.81 in) D, Approx. 2.9 kg (102.3 oz)
Accessories	Power cord × 1, Instruction manual × 1, Operation guide × 1 EXT.I/O male connector × 1

Measurement Method

Measurement types	DC resistance
Measurement signal	Constant current
Measurement method	Four-terminal DC
Measurement terminals	22 mm pitch BNC female terminal
Measurement speed	FAST/MED/SLOW

Comparator Function

(Determination method: REF% Mode/ABS Mode)

Measurement range	REF% (Relative Value Determination) Mode <ul style="list-style-type: none"> Reference value: Setting range 0.00 mΩ to 120.00 MΩ (LOW POWER: OFF) 0.0 mΩ to 1200.0 Ω (LOW POWER: ON) <ul style="list-style-type: none"> Upper/Lower limit value: Setting range -9.999% to 9.999% (when less than 10%) -99.99% to 99.99% (when 10% or greater)
	ABS (Absolute Value Determination) Mode <ul style="list-style-type: none"> Upper/Lower limit value: Setting range 0.00 mΩ to 120.00 MΩ (LOW POWER: OFF) 0.0 mΩ to 1200.0 Ω (LOW POWER: ON)
Judgment	COMP lamp (Hi/IN/Lo), external output, beeping sound: IN, HI/LO, LOW, HIGH (default setting OFF)

Contact Check Function

Operation details	Checks the connections between the H _{POT} -H _{CUR} terminals and between the L _{POT} -L _{CUR} terminals (for each range)
Threshold value	50 Ω/ 100 Ω/ 150 Ω/ 200 Ω (default value)/ 300 Ω/ 400 Ω/ 500 Ω
Judgment	Error display (CE_HI/CE_LO), external output
Implementation timing	Before integration time (response time) until measuring is in progress

Trigger/Delay Function

Trigger (Select)	Internal trigger (automatic continuous measurement) External trigger (measurements are triggered by an external signal)
Delay	DELAY 1: Common to all ranges Mechanical adjustment of stable time during probe contact Measurement range: 0.0 ms to 100.0 ms
	DELAY 2: Each range Adjustment of time from the application of a measurement current (such as an inductor) until the value is stable
	Measurement range: 0.0 ms to 100.0 ms

Measurement Time: Power supply frequency 50 Hz (60 Hz), default settings

Color: RM3542A only

Tolerance: ±10% ±0.2 ms

Range	LOW POWER: OFF		
	FAST	MED	SLOW
100 mΩ	3.8 ms	13 ms	43 ms (36 ms)
1000 mΩ	2.0 ms	6.4 ms	41 ms (35 ms)
3 Ω	1.6 ms	6.0 ms	41 ms (34 ms)
10 Ω	1.6 ms	6.0 ms	41 ms (34 ms)
100 Ω	0.9 ms	3.6 ms	21 ms (17 ms)
300 Ω	0.9 ms	3.6 ms	21 ms (17 ms)
1000 Ω	0.9 ms	3.6 ms	21 ms (17 ms)
10 kΩ	1.0 ms	3.6 ms	21 ms (17 ms)
30 kΩ	0.9 ms	3.6 ms	21 ms (17 ms)
100 kΩ	1.3 ms	3.8 ms	21 ms (18 ms)
300 kΩ	1.3 ms	3.8 ms	21 ms (18 ms)
1000 kΩ	2.5 ms	6.0 ms	21 ms (18 ms)
3 MΩ	2.5 ms	6.0 ms	21 ms (18 ms)
10 MΩ	5.3 ms	23 ms (20 ms)	23 ms (20 ms)
30 MΩ	5.8 ms	23 ms (20 ms)	23 ms (20 ms)
100 MΩ	26 ms (22 ms)	46 ms (39 ms)	86 ms (72 ms)

Range	LOW POWER: ON		
	FAST	MED	SLOW
1000 mΩ	2.3 ms*	12 ms	42 ms (35 ms)
3 Ω	2.3 ms	12 ms	42 ms (35 ms)
10 Ω	2.3 ms*	12 ms	42 ms (35 ms)
100 Ω	1.7 ms	6.1 ms	41 ms (34 ms)
300 Ω	3.2 ms	7.6 ms	36 ms (43 ms)
1000 Ω	7.2 ms	12 ms	47 ms (40 ms)

* Add 0.2ms when using the RM3542

OVC Function (Offset Voltage Compensation)

Operation details	Inverts current polarity to remove offset caused by thermal EMF
Effective range	LOW POWER OFF: 100 mΩ range to 10 Ω range LOW POWER ON: All ranges

Recording/Interface

Memory storage	Measurement values are recorded by the EXT.I/O TRIG signal and F4 [MANU] button.
	Number of memory slots: 30000 (volatile memory, no backup)
Auto-Memory Function	Statistical Calculation Functions: Statistical calculations are performed for measurement values saved to memory. (Calculation contents: Total data count, average value, minimum value, maximum value, sample standard deviation, population standard deviation, process capability index) Calculation results: Displayed on screen/printed
	Loading when measured value is stable, with manual measurement by internal continuous trigger (A beeping sound is heard if the specified value is reached.) Memory slots: 1 to 99
Interface	EXT.I/O, RS-232C, Printer, Settings Monitor Function terminals (SET MONITOR terminals), GP-IB (RM3542-51, RM3542-01 only)

RS-232C

Connector	D-sub 9-pin connector
Flow control	None
Transmission rate	9600 bps, 19200 bps, 38400 bps

GP-IB (RM3542-01 and RM3542-51 only)

Connector	24-pin Centronics type connector
Compliance standard	IEEE-488.1 1987
Reference standard	IEEE-488.2 1987
Terminator	LF, CR+LF

Measurement Specifications Color: RM3542A only

Resistance measurement accuracy Accuracy guaranteed for 1 year, Post-adjustment accuracy guaranteed for 1 year

Conditions of guaranteed accuracy

Warm-up time 30 minutes or more

Integration time Longer than the default value for the Integration Time Setting Function
(No regulation for settings in ms if the default value is set to PLC)

Temperature and humidity range for guaranteed accuracy 23°C ±5°C (73°F ±9°F), 80% RH or less

Temperature fluctuation after self-calibration must be within ±2°C (±3.6°F). Add Temperature Coefficient ±(1/10 of measurement accuracy)/°C for the following ranges: 0°C to 18°C (32°F to 64°F) and 28°C to 40°C (82°F to 104°F).

LOW POWER: OFF

Range	Maximum Display Value ¹	Resolution	Measurement Accuracy: ± (%rdg. + % f.s.)			Measurement Current ²	Open-Circuit Voltage
			FAST	MED	SLOW		
100 mΩ	120.0000 mΩ	100 nΩ	0.015 + 0.008	0.015 + 0.003	0.015 + 0.002	100 mA	20 V max *3, *4, *5
1000 mΩ	1200.000 mΩ	1 μΩ	0.012 + 0.003	0.012 + 0.002	0.012 + 0.001	100 mA	
3 Ω	3.60000 Ω	10 μΩ	0.012 + 0.003	0.012 + 0.002	0.012 + 0.001	33.3 mA	
10 Ω	12.00000 Ω	10 μΩ	0.010 + 0.003	0.008 + 0.002	0.008 + 0.001	10 mA	
100 Ω	120.0000 Ω	100 μΩ	0.009 + 0.003	0.007 + 0.002	0.007 + 0.001	10 mA	
300 Ω	360.000 Ω	1 mΩ	0.009 + 0.003	0.007 + 0.002	0.007 + 0.001	3.33 mA	
1000 Ω	1200.000 Ω	1 mΩ	0.008 + 0.003	0.006 + 0.002	0.006 + 0.001	1 mA	
10 kΩ	12.00000 kΩ	10 mΩ	0.009 + 0.003	0.007 + 0.002	0.007 + 0.001	1 mA	
30 kΩ	36.0000 kΩ	100 mΩ	0.009 + 0.003	0.007 + 0.002	0.007 + 0.001	333 μA	
100 kΩ	120.0000 kΩ	100 mΩ	0.010 + 0.003	0.007 + 0.002	0.007 + 0.001	100 μA	
300 kΩ	360.000 kΩ	1 Ω	0.010 + 0.003	0.007 + 0.002	0.007 + 0.001	33.3 μA	
1000 kΩ	1200.000 kΩ	1 Ω	0.010 + 0.003	0.008 + 0.002	0.008 + 0.001	10 μA	
3 MΩ	3.60000 MΩ	10 Ω	0.010 + 0.003	0.008 + 0.002	0.008 + 0.001	3.33 μA	
10 MΩ	12.00000 MΩ	10 Ω	0.030 + 0.004			1 μA	
30 MΩ	36.0000 MΩ	100 Ω	0.030 + 0.010			333 nA	
100 MΩ	120.0000 MΩ	100 Ω	0.100 + 0.020			100 nA	

LOW POWER: ON

Range	Maximum Display Value ¹	Resolution	Measurement Accuracy: ± (%rdg. + % f.s.)			Measurement Current ²	Open-Circuit Voltage
			FAST	MED	SLOW		
1000 mΩ	1200.000 mΩ	1 μΩ	0.010 + 0.008	0.008 + 0.003	0.008 + 0.002	10 mA	10 V max (RM3542A) *3, *5
3 Ω	3.60000 Ω	10 μΩ	0.010 + 0.008	0.008 + 0.003	0.008 + 0.002	3.33 mA	
10 Ω	12.00000 Ω	10 μΩ	0.010 + 0.008	0.008 + 0.003	0.008 + 0.002	1 mA	20 V max (RM3542) *3, *5
100 Ω	120.0000 Ω	100 μΩ	0.010 + 0.003	0.008 + 0.002	0.008 + 0.001	1 mA	
300 Ω	360.000 Ω	1 mΩ	0.010 + 0.003	0.008 + 0.002	0.008 + 0.001	333 μA	
1000 Ω	1200.000 Ω	1 mΩ	0.020 + 0.003	0.008 + 0.002	0.008 + 0.001	100 μA	

¹Negative values can be up to 10% of positive full scale.

²Measurement current accuracy is ±5%.

³Voltage when not measuring is 20 mV or less, with current mode set at PULSE and Contact Improver Setting set at OFF/PULSE (with a voltmeter having 10 MΩ).

⁴VOLTAGE LIMIT ON: 10 V max

⁵With the sum of resistances of the probes, sample, and contacts less than (open-circuit voltage) / (measurement current).

Example. 100 mA measurement current can be used when the sum of resistances of the probes, sample, and contacts is no more than 20 Ω.

Dimensions (Units: mm)

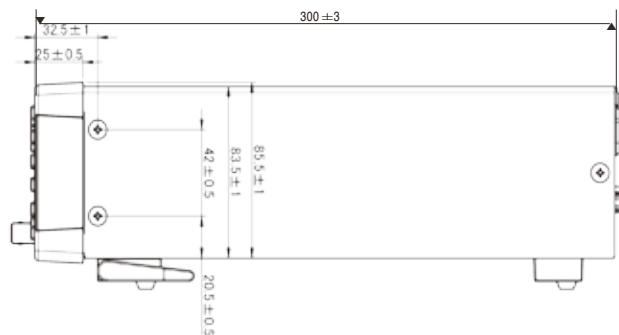

Recommended Model for Each Type of Measurement

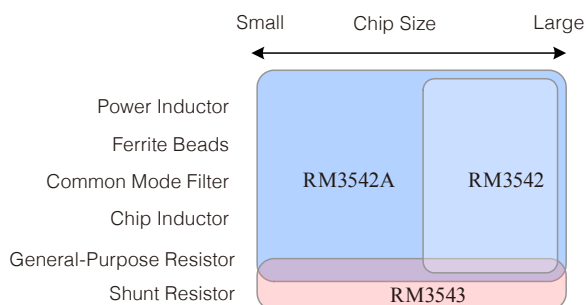

Related Products

Resistance Meter for the Ultra-Low Shunt Era RM3543



- Inspection of 0.1 mΩ at a high accuracy of 0.16%, and a high resolution of 0.01 μΩ. Shunt resistor load inspection with superior accuracy and resolution.
 - Excellent repetitive measurement accuracy
 - Intuitive user interface and superb noise immunity ideal for use with automated equipment
- RM3543
RM3543-01 (With GP-IB)

Product Name: RESISTANCE METER RM3542A

Model No. (Order Code)	GP-IB
RM3542-50	—
RM3542-51	Included

Product Name: RESISTANCE METER RM3542

Model Name (Order code)	GP-IB
RM3542	—
RM3542-01	Included

Options

Probes and Fixtures (for connection to measurement terminals)

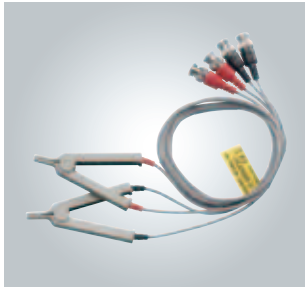

FOUR-TERMINAL PROBE 9140-10
(for RM3542A)
FOUR-TERMINAL PROBE 9140
(for RM3542)

For test lead parts
Diameter of supported measurement terminals: 0.3 to 5 mm (0.01 to 0.20 in)
Cable length: 1 m (3.28 ft)



TEST FIXTURE 9262

For test lead parts
Diameter of supported measurement terminals: 0.3 to 2 mm (0.01 to 0.08 in)
Pitch of test lead: 5 mm (0.20 in) or greater
Connects directly to main unit



SMD TEST FIXTURE 9263

For SMD with electrodes on the sides
Supported sample sizes:
2012 to 5750 (JIS)
0805 to 2220 (EIA)
Sample width: 1 to 10 mm (0.04 to 0.39 in)
Connects directly to main unit



SMD TEST FIXTURE IM9100

For SMD with electrodes on the bottom
Supported sample sizes:
0402 to 1005 (JIS)
01005 to 0402 (EIA)
Connects directly to main unit

See the product catalogs for details.

■ Recommended Measurement Cable Specifications

Conductor resistance	500 mΩ/m or less
Capacitance	150 pF/m or less
Cable dielectric material	Polyethylene (PE), Teflon* (TFE), Polyethylene Foam (PEF) Insulation resistance: 10 GΩ or greater
Connector insulator material	Teflon* (TFE), Polybutylene Terephthalate (PBT) Insulation resistance: 10 GΩ or greater
Length	2 m (6.56 ft) or less
Recommended cables (examples)	JIS Standard 3C-2V, 1.5D-2V, MIL Standard RG-58A/U

*Teflon is a registered trademark of DUPONT, Inc.

Communication Interfaces

RS-232C CABLE 9637



9pin-9pin, cross
Cord length: 1.8 m (5.91 ft)

RS-232C CABLE 9638



9pin-25pin, cross
Cord length: 1.8 m (5.91 ft)

GP-IB CONNECTION CABLE 9151-02



Cord length: 2 m (6.56 ft)

HIOKI
HIOKI E. E. CORPORATION

HEADQUARTERS
81 Koizumi, Ueda, Nagano, 386-1192, Japan
TEL +81-268-28-0562 FAX +81-268-28-0568
<http://www.hioki.com> / E-mail: os-com@hioki.co.jp

HIOKI USA CORPORATION
TEL +1-609-409-9109 FAX +1-609-409-9108
<http://www.hiokiusa.com> / E-mail: hioki@hiokiusa.com

HIOKI (Shanghai) SALES & TRADING CO., LTD.
TEL +86-21-63910090 FAX +86-21-63910360
<http://www.hioki.cn> / E-mail: info@hioki.com.cn

HIOKI INDIA PRIVATE LIMITED
TEL +91-124-6590210
E-mail: hioki@hioki.in

HIOKI SINGAPORE PTE. LTD.
TEL +65-6634-7677 FAX +65-6634-7477
E-mail: info-sg@hioki.com.sg

HIOKI KOREA CO., LTD.
TEL +82-2-2183-8847 FAX +82-2-2183-3360
E-mail: info-kr@hioki.co.jp

DISTRIBUTED BY

Note: Company names and Product names appearing in this catalog are trademarks or registered trademarks of various companies.